

# Electric Airless Sprayers

3A6519B

EN

***For professional use only.***

***Not approved for use in explosive atmospheres or hazardous locations.***

***For portable airless spraying of architectural paints and coatings.***

**Ultra 395 PC, Ultimate NOVA 395 PC, Ultra 395 PC Pro**  
3300 psi (228 bar, 22.8 MPa) Maximum Working Pressure

See page 3 for additional model information.



## Important Safety Instructions

Read all warnings and instructions in this manual, in related manuals, and on the unit, before using the equipment. Be familiar with the controls and the proper usage of the equipment. Save these instructions.

### Related Manuals

Gun– 3A6285 (Contractor PC)

Pump – 334599

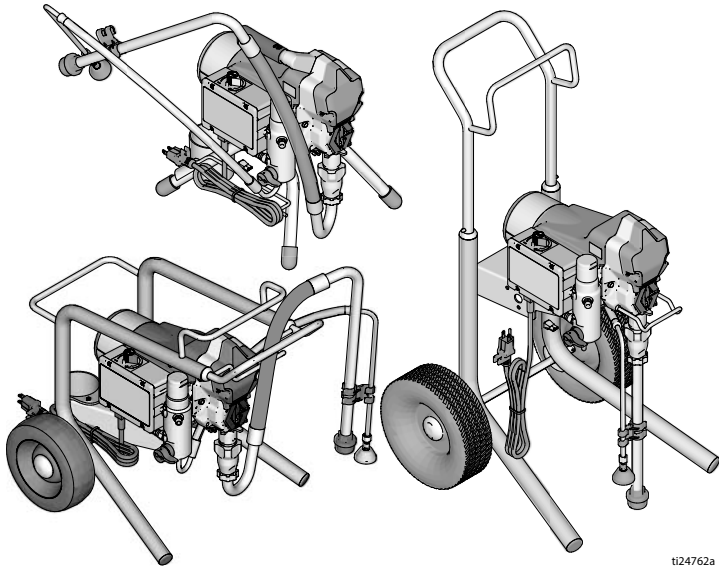

ti24762a







*Use only genuine Graco replacement parts.  
The use of non-Graco replacement parts may void warranty.*

## Contents

|  |           |
|--|-----------|
| <b>Models</b> .....                    | <b>3</b>  |
| <b>Warnings</b> .....                  | <b>4</b>  |
| <b>Component Identification</b> .....  | <b>8</b>  |
| Stand Models .....                     | 8         |
| Lo-Boy Models .....                    | 9         |
| Hi-Boy Models .....                    | 10        |
| <b>Grounding</b> .....                 | <b>11</b> |
| Power Requirements .....               | 11        |
| Extension Cords .....                  | 11        |
| Pails .....                            | 11        |
| <b>Pressure Relief Procedure</b> ..... | <b>12</b> |
| <b>Setup</b> .....                     | <b>14</b> |
| <b>Startup</b> .....                   | <b>17</b> |
| <b>Operation</b> .....                 | <b>19</b> |
| Spray Tip Installation .....           | 19        |
| Spray .....                            | 19        |
| Adjust Pressure Control .....          | 20        |
| Spray Pattern Quality .....            | 20        |
| Spray Techniques .....                 | 20        |
| Triggering Spray Gun .....             | 21        |
| Aiming Spray Gun .....                 | 21        |
| Clear Spray Tip Clog .....             | 21        |
| Digital Display .....                  | 22        |
| <b>Cleanup</b> .....                   | <b>24</b> |
| <b>Maintenance</b> .....               | <b>27</b> |
| <b>Troubleshooting</b> .....           | <b>28</b> |
| Mechanical/Fluid Flow .....            | 28        |
| Electrical .....                       | 31        |
| <b>Stand Sprayers</b> .....            | <b>41</b> |
| <b>395 Lo-Boy Sprayers</b> .....       | <b>44</b> |
| <b>Hi-Boy Sprayers</b> .....           | <b>47</b> |
| <b>Accessories and Labels</b> .....    | <b>50</b> |
| <b>Control Box</b> .....               | <b>51</b> |
| <b>Wiring Diagrams</b> .....           | <b>53</b> |
| <b>Technical Specifications</b> .....  | <b>55</b> |
| <b>Graco Standard Warranty</b> .....   | <b>59</b> |
| <b>Graco Information</b> .....         | <b>60</b> |

## Models

|   | VAC        | Model                   | Stand<br> | Lo-Boy<br> | Hi-Boy<br> |
|---|------------|-------------------------|--|---|--|
| <br>Intertek<br>110474<br>Certified to<br>CAN/CSA<br>C22.2 No. 68<br>Conforms to<br>UL 1450 | 120<br>USA | Ultra 395 PC            | 17E844   | 17E845  | 17E846   |
|   |            | Ultimate NOVA<br>395 PC | 826237   | 826238  | 826239   |
|   | 230ANZ     | Ultra 395 PC Pro        | 17E881   |   |  |

## Warnings

The following warnings are for the setup, use, grounding, maintenance, and repair of this equipment. The exclamation point symbol alerts you to a general warning and the hazard symbols refer to procedure-specific risks. When these symbols appear in the body of this manual or on warning labels, refer back to these Warnings. Product-specific hazard symbols and warnings not covered in this section may appear throughout the body of this manual where applicable.

### **WARNING**



#### **GROUNDING**

This product must be grounded. In the event of an electrical short circuit, grounding reduces the risk of electric shock by providing an escape wire for the electric current. This product is equipped with a cord having a grounding wire with an appropriate grounding plug. The plug must be plugged into an outlet that is properly installed and grounded in accordance with all local codes and ordinances.

- Improper installation of the grounding plug is able to result in a risk of electric shock.
- When repair or replacement of the cord or plug is required, do not connect the grounding wire to either flat blade terminal.
- The wire with insulation having an outer surface that is green with or without yellow stripes is the grounding wire.
- Check with a qualified electrician or serviceman when the grounding instructions are not completely understood, or when in doubt as to whether the product is properly grounded.
- Do not modify the plug provided; if it does not fit the outlet, have the proper outlet installed by a qualified electrician.
- This product is for use on a nominal 120 V or 230 V circuit and has a grounding plug similar to the plugs illustrated in the figure below.

120V US



230V

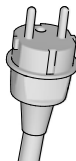

230V ANZ



ti24583a

- Only connect the product to an outlet having the same configuration as the plug.
- Do not use a 3-to-2 adapter with this product.

#### Extension Cords:

- Use only a 3-wire extension cord that has a grounding plug and a grounding receptacle that accepts the plug on the product.
- Make sure your extension cord is not damaged. If an extension cord is necessary, use 12 AWG (2.5 mm<sup>2</sup>) minimum to carry the current that the product draws.
- An undersized cord results in a drop in line voltage and loss of power and overheating.

**WARNING**
**FIRE AND EXPLOSION HAZARD**

Flammable fumes, such as solvent and paint fumes, in work area can ignite or explode. To help prevent fire and explosion:



- Do not spray flammable or combustible materials near an open flame or sources of ignition such as cigarettes, motors, and electrical equipment.



- Paint or solvent flowing through the equipment is able to result in static electricity. Static electricity creates a risk of fire or explosion in the presence of paint or solvent fumes. All parts of the spray system, including the pump, hose assembly, spray gun, and objects in and around the spray area shall be properly grounded to protect against static discharge and sparks. Use Graco conductive or grounded high-pressure airless paint sprayer hoses.



- Verify that all containers and collection systems are grounded to prevent static discharge. Do not use pail liners unless they are anti-static or conductive.
- Connect to a grounded outlet and use grounded extensions cords. Do not use a 3-to-2 adapter.
- Do not use a paint or a solvent containing halogenated hydrocarbons.
- Do not spray flammable or combustible liquids in a confined area.
- Keep spray area well-ventilated. Keep a good supply of fresh air moving through the area.
- Sprayer generates sparks. Keep pump assembly in a well-ventilated area at least 20 feet (6.1 m) from the spray area when spraying, flushing, cleaning, or servicing. Do not spray pump assembly.
- Do not smoke in the spray area or spray where sparks or flame is present.
- Do not operate light switches, engines, or similar spark producing products in the spray area.
- Keep area clean and free of paint or solvent containers, rags, and other flammable materials.
- Know the contents of the paints and solvents being sprayed. Read all Safety Data Sheets (SDSs) and container labels provided with the paints and solvents. Follow the paint and solvent manufacturer's safety instructions.
- Keep a working fire extinguisher in the work area.

# Warnings

## **WARNING**



### **SKIN INJECTION HAZARD**

High-pressure spray is able to inject toxins into the body and cause serious bodily injury. In the event that injection occurs, **get immediate surgical treatment.**



- Do not aim the gun at, or spray any person or animal.
- Keep hands and other body parts away from the discharge. For example, do not try to stop leaks with any part of the body.



- Always use the nozzle tip guard. Do not spray without nozzle tip guard in place.



- Use Graco nozzle tips.
- Use caution when cleaning and changing nozzle tips. In the case where the nozzle tip clogs while spraying, follow the **Pressure Relief Procedure** for turning off the unit and relieving the pressure before removing the nozzle tip to clean.



- Equipment maintains pressure after power is shut off. Do not leave the equipment energized or under pressure while unattended. Follow the **Pressure Relief Procedure** when the equipment is unattended or not in use, and before servicing, cleaning, or removing parts.
- Check hoses and parts for signs of damage. Replace any damaged hoses or parts.
- This system is capable of producing 3300 psi. Use Graco replacement parts or accessories that are rated a minimum of 3300 psi.
- Always engage the trigger lock when not spraying. Verify the trigger lock is functioning properly.
- Verify that all connections are secure before operating the unit.
- Know how to stop the unit and bleed pressure quickly. Be thoroughly familiar with the controls.



### **EQUIPMENT MISUSE HAZARD**

Misuse can cause death or serious injury.



- Always wear appropriate gloves, eye protection, and a respirator or mask when painting.
- Do not operate or spray near children. Keep children away from equipment at all times.
- Do not overreach or stand on an unstable support. Keep effective footing and balance at all times.
- Stay alert and watch what you are doing.
- Do not operate the unit when fatigued or under the influence of drugs or alcohol.
- Do not kink or over-bend the hose.
- Do not expose the hose to temperatures or to pressures in excess of those specified by Graco.
- Do not use the hose as a strength member to pull or lift the equipment.
- Do not spray with a hose shorter than 25 feet.
- Do not alter or modify equipment. Alterations or modifications may void agency approvals and create safety hazards.
- Make sure all equipment is rated and approved for the environment in which you are using it.

## **WARNING**



### **ELECTRIC SHOCK HAZARD**

This equipment must be grounded. Improper grounding, setup, or usage of the system can cause electric shock.

- Turn off and disconnect power cord before servicing equipment.
- Connect only to grounded electrical outlets.
- Use only 3-wire extension cords.
- Ensure ground prongs are intact on power and extension cords.
- Do not expose to rain. Store indoors.



### **PRESSURIZED ALUMINUM PARTS HAZARD**

Use of fluids that are incompatible with aluminum in pressurized equipment can cause serious chemical reaction and equipment rupture. Failure to follow this warning can result in death, serious injury, or property damage.

- Do not use 1,1,1-trichloroethane, methylene chloride, other halogenated hydrocarbon solvents or fluids containing such solvents.
- Do not use chlorine bleach.
- Many other fluids may contain chemicals that can react with aluminum. Contact your material supplier for compatibility.



### **MOVING PARTS HAZARD**

Moving parts can pinch, cut or amputate fingers and other body parts.

- Keep clear of moving parts.
- Do not operate equipment with protective guards or covers removed.
- Equipment can start without warning. Before checking, moving, or servicing equipment, follow the Pressure Relief Procedure and disconnect all power sources.



### **TOXIC FLUID OR FUMES HAZARD**

Toxic fluids or fumes can cause serious injury or death if splashed in the eyes or on skin, inhaled, or swallowed.

- Read Safety Data Sheets (SDSs) to know the specific hazards of the fluids you are using.
- Store hazardous fluid in approved containers, and dispose of it according to applicable guidelines.



### **PERSONAL PROTECTIVE EQUIPMENT**

Wear appropriate protective equipment when in the work area to help prevent serious injury, including eye injury, hearing loss, inhalation of toxic fumes, and burns. This protective equipment includes but is not limited to:

- Protective eyewear, and hearing protection.
- Respirators, protective clothing, and gloves as recommended by the fluid and solvent manufacturer.

# Component Identification

## Component Identification

### Stand Models

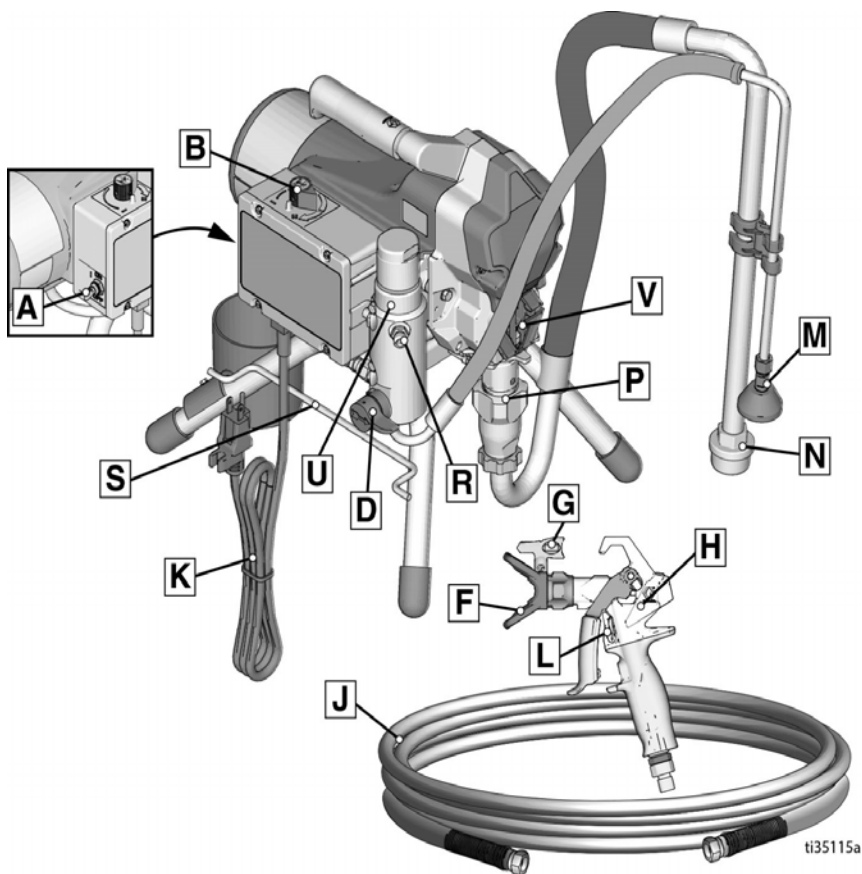

|   |                  |
|---|------------------|
| A | ON/OFF Switch    |
| B | Pressure Control |
| D | Prime Valve      |
| F | Tip Guard        |
| G | Spray Tip        |
| H | Gun              |
| J | Airless Hose     |
| K | Power Cord       |
| L | Trigger Lock     |
| M | Drain Tube       |

|   |  |
|---|--|
| N | Fluid Intake   |
| P | Pump   |
| R | Fluid Outlet   |
| S | Power Cord Wrap  |
| U | Filter   |
| V | Finger Guard / TSL Fill Point                            |
|   | Model/Serial Tag (Not shown, located on bottom of unit.) |



# Component Identification

## Lo-Boy Models

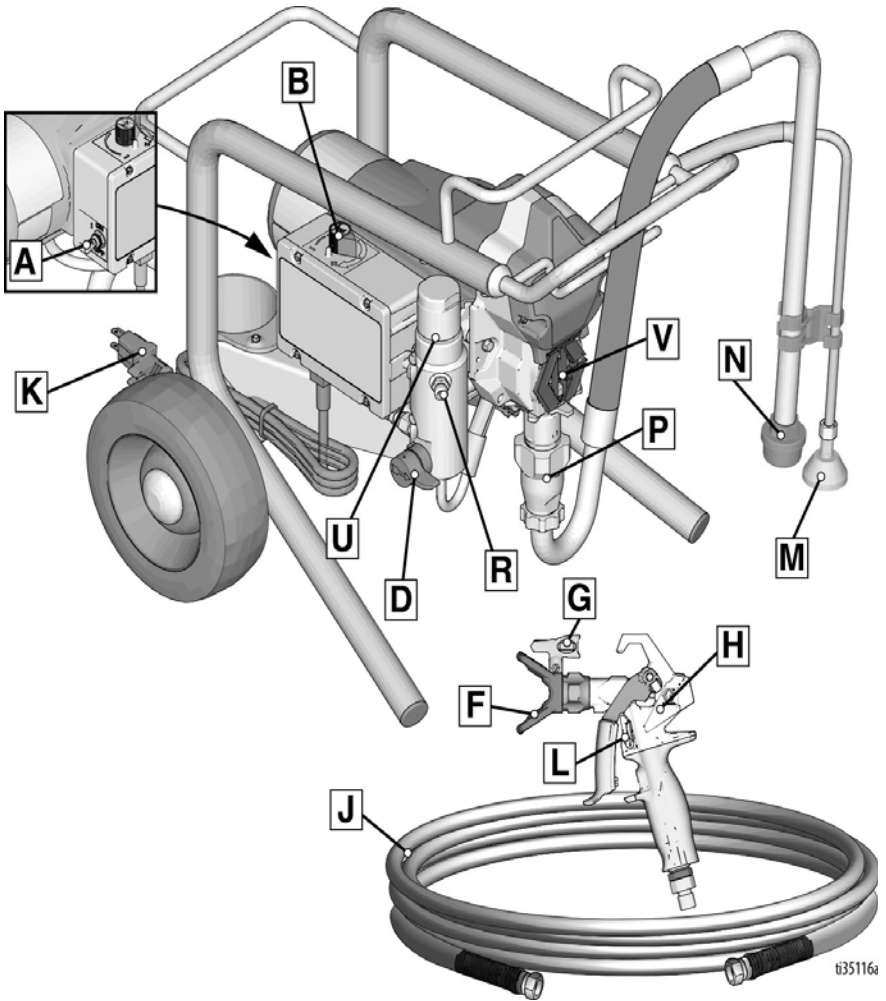

|   |                  |
|---|------------------|
| A | ON/OFF Switch    |
| B | Pressure Control |
| D | Prime Valve      |
| F | Tip Guard        |
| G | Spray Tip        |
| H | Gun              |
| J | Airless Hose     |
| K | Power Cord       |

|   |  |
|---|--|
| L | Trigger Lock   |
| M | Drain Tube   |
| N | Fluid Intake   |
| P | Pump   |
| R | Fluid Outlet   |
| U | Filter   |
| V | Finger Guard / TSL Fill Point                            |
|   | Model/Serial Tag (Not shown, located on bottom of unit.) |

# Component Identification

## Hi-Boy Models

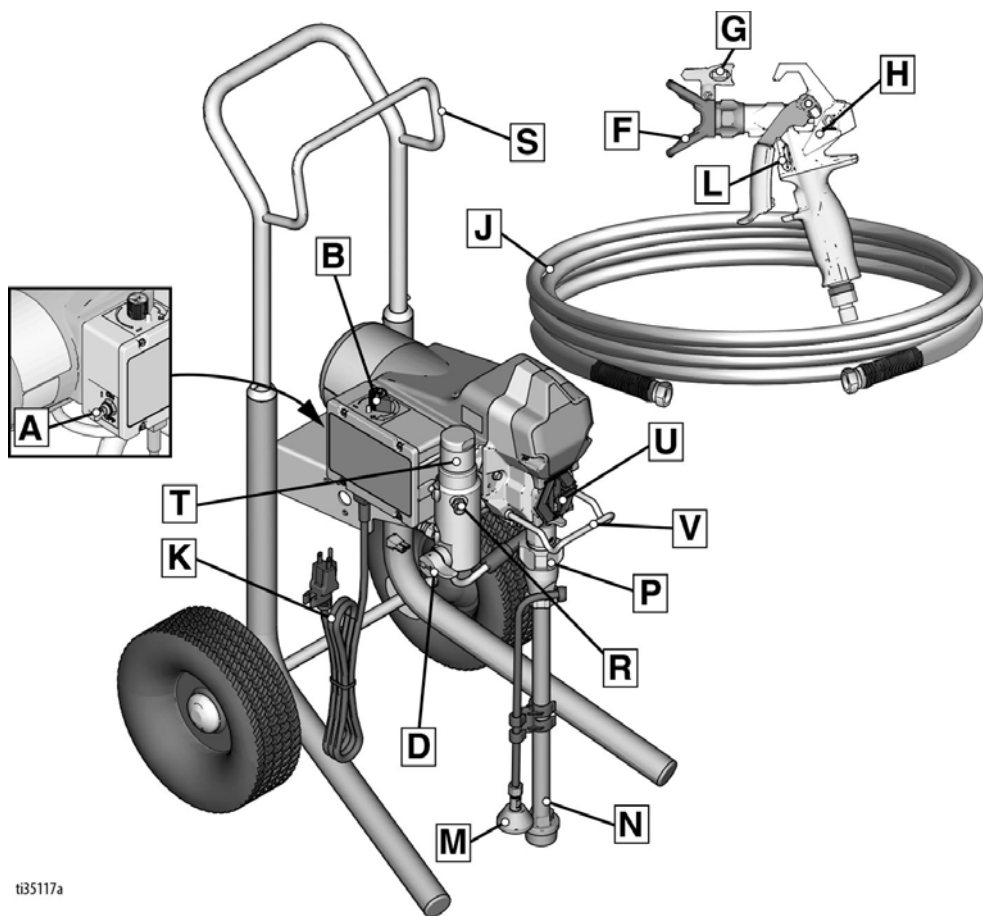

ti35117a

## Hi-Boy Models

|   |                  |
|---|------------------|
| A | ON/OFF Switch    |
| B | Pressure Control |
| D | Prime Valve      |
| F | Tip Guard        |
| G | Spray Tip        |
| H | Gun              |
| J | Airless Hose     |
| K | Power Cord       |
| L | Trigger Lock     |

|   |  |
|---|--|
| M | Drain Tube   |
| N | Fluid Intake   |
| P | Pump   |
| R | Fluid Outlet   |
| S | Hanger   |
| T | Filter   |
| U | Finger Guard / TSL Fill Point                            |
| V | Pail Hook  |
|   | Model/Serial Tag (Not shown, located on bottom of unit.) |

# Grounding



The equipment must be grounded to reduce the risk of static sparking and electric shock. An electric or static spark can cause fumes to ignite or explode. An improper ground can cause electric shock. A good ground provides an escape wire for the electric current.

This sprayer is equipped with a power cord that has a ground wire and an appropriate grounding plug.

The plug must be plugged into an outlet that is properly installed and grounded in accordance with all local codes and ordinances.

Do not modify the plug provided; if it does not fit the outlet, have the proper outlet installed by a qualified electrician.

## Power Requirements

- 110-120V units require 100-120 VAC, 50/60 Hz, 15A, 1 phase.
- 230V units require 230 VAC, 50/60 HZ, 7A, 1 phase.

## Extension Cords

Use an extension cord with an undamaged ground contact. If an extension cord is necessary, use a 3-wire, 12 AWG (2.5 mm<sup>2</sup>) minimum.

**NOTE:** Smaller gauge or longer extension cords may reduce sprayer performance.

## Pails

**Solvent and oil-based fluids:** follow local code. Use only conductive metal pails, placed on a grounded surface such as concrete.

Do not place pail on a non-conductive surface such as paper or cardboard which interrupts grounding continuity.

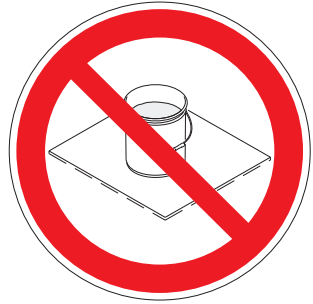

**Always ground a metal pail:** connect a ground wire to the pail. Clamp one end to the pail and the other end to a true earth ground such as a water pipe.

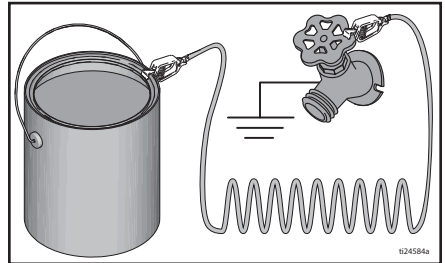

**To maintain ground continuity when sprayer is flushed or pressure is relieved:** hold metal part of spray gun firmly to the side of a grounded metal pail then trigger the gun.



# Pressure Relief Procedure

## Pressure Relief Procedure



Follow the Pressure Relief Procedure whenever you see this symbol.

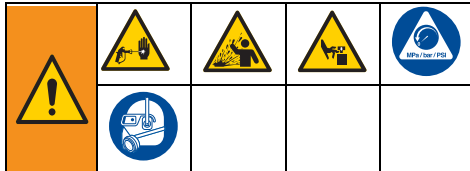

This equipment stays pressurized until pressure is manually relieved. To help prevent serious injury from pressurized fluid, such as skin injection, splashed fluid and moving parts, follow the Pressure Relief Procedure whenever sprayer is stopped and before sprayer is cleaned or checked, and before equipment is serviced.

1. Turn the ON/OFF switch to **OFF** position.

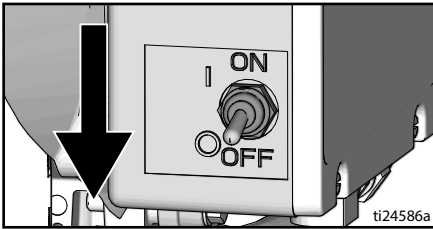

2. Engage the trigger lock.

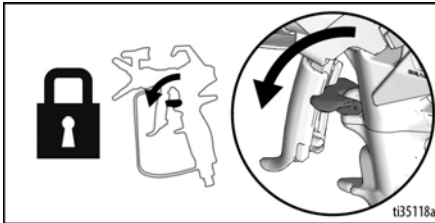

3. Turn pressure control to lowest setting. Disengage the trigger lock.

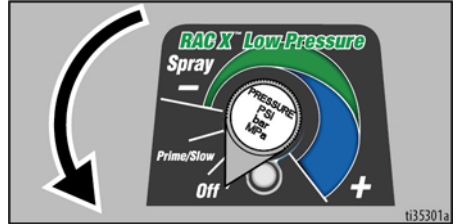

4. Hold a metal part of the gun firmly to a grounded metal pail. Trigger the gun to relieve pressure.

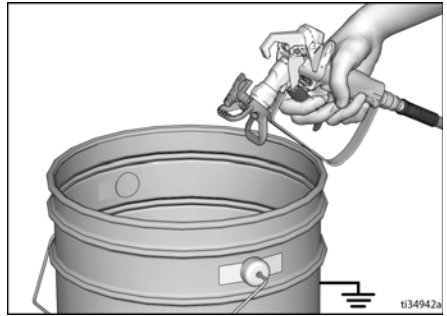

5. Engage the trigger lock.

# Pressure Relief Procedure

6. Turn the prime valve down. Put drain tube in a pail. Leave prime valve in the down (drain) position until you are ready to spray again.

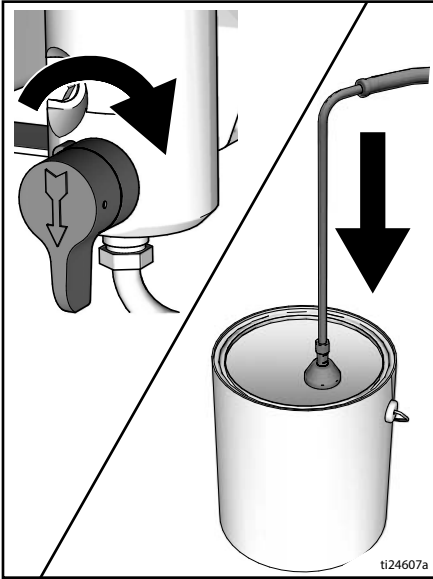

7. If you suspect the spray tip or hose is clogged or that pressure has not been fully relieved:
  - a. **VERY SLOWLY** loosen the tip guard retaining nut or the hose end coupling to relieve pressure gradually.
  - b. Loosen the nut or coupling completely.
  - c. Clear hose or tip obstruction.

## Trigger Lock

Always engage the trigger lock when sprayer is stopped to prevent the gun from being triggered accidentally by hand or if dropped or bumped.

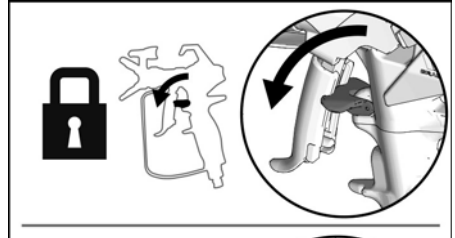

# Setup

## Setup

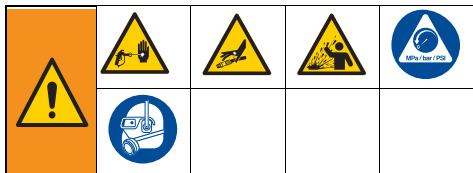

When unpacking sprayer for the first time or after long term storage perform setup procedure. When first setup is performed remove shipping plug from fluid outlet.

1. Connect Graco airless hose to fluid outlet. Use wrenches to tighten securely.

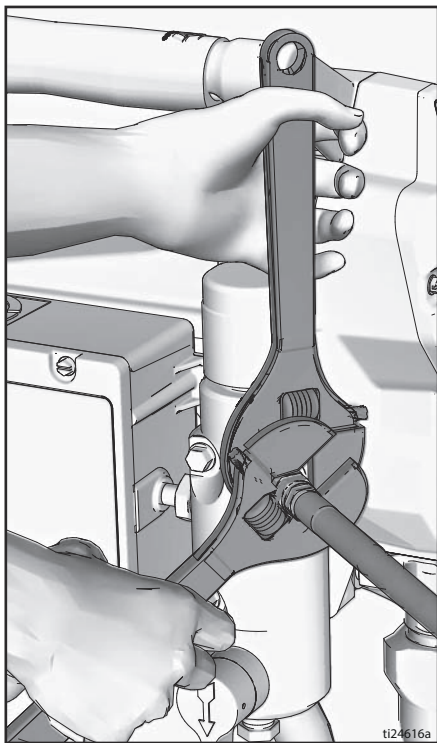

2. Connect other end of hose to gun.

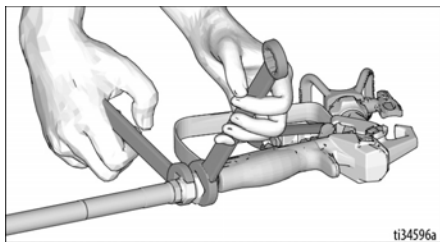

3. Use wrenches to tighten securely.
4. Engage trigger lock.

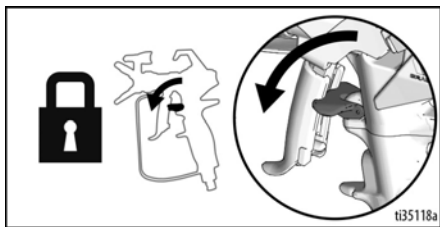

5. Remove tip guard.

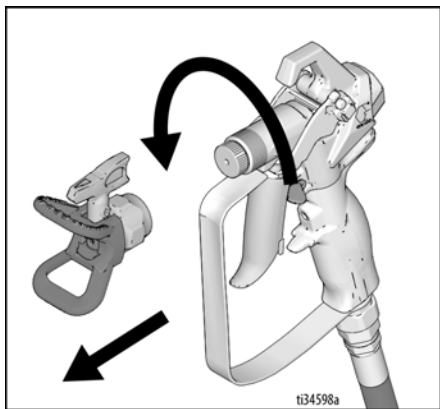

6. When unpacking sprayer for the first time remove packaging materials from

inlet strainer. After long term storage check inlet strainer for clogs and debris.

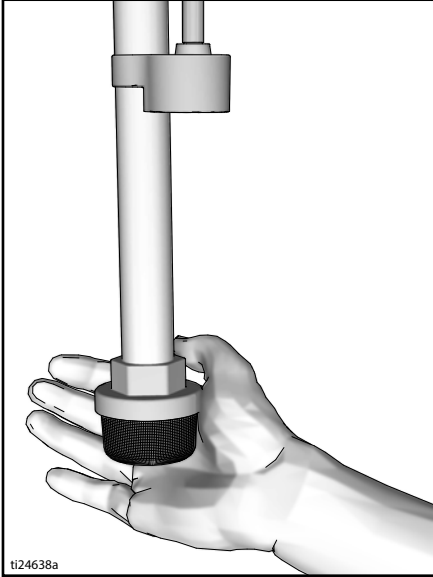

7. Fill throat packing nut with TSL to prevent premature packing wear. Do this daily or each time you spray.
  - a. Place the TSL bottle nozzle into the top center opening in the finger guard at the front of the sprayer.
  - b. Squeeze bottle to dispense enough TSL to fill the space between the pump rod and packing nut seal.

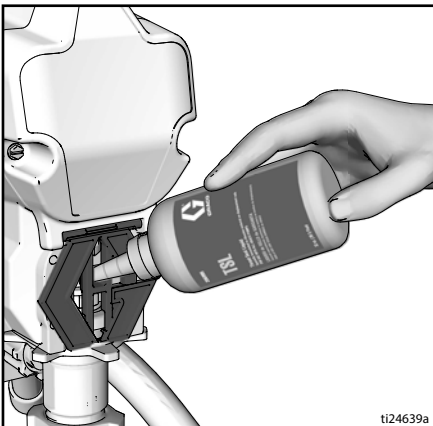

8. Make certain ON/OFF switch is OFF.

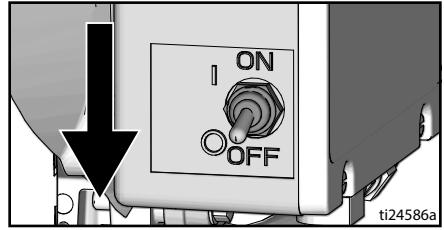

9. Plug power supply cord into a properly grounded electrical outlet.

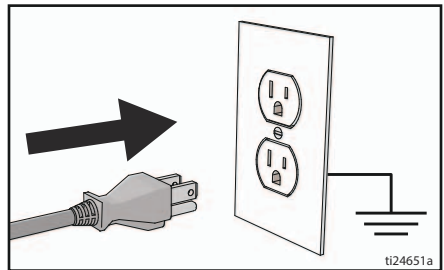

10. Turn prime valve down.

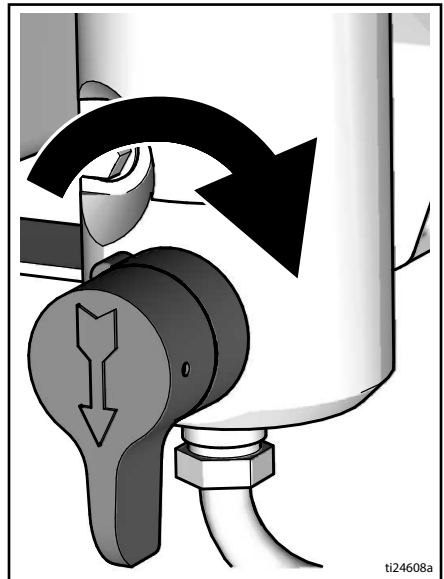

# Setup

11. Place fluid intake with drain tube in grounded metal pail partially filled with flushing fluid. See **Grounding**, page 11.

**NOTE:** New sprayers are shipped with storage fluid that must be flushed out with mineral spirits prior to using the sprayer.

Check flushing fluid for compatibility with material that is to be sprayed. A secondary flush with a compatible fluid may be necessary. Water for latex paint or mineral spirits for oil-based paint.

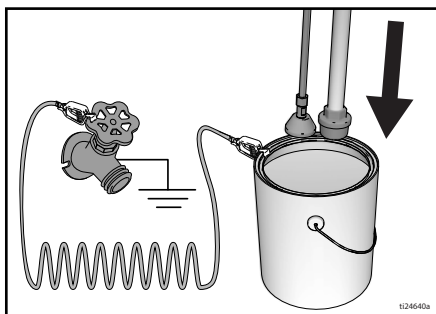

12. Turn pressure control to lowest setting.
13. Turn ON/OFF switch to **ON** position.
14. Increase pressure 1/2 turn to start motor. Allow fluid to flush through sprayer for one minute.

15. Turn prime valve horizontal. Disengage trigger lock.

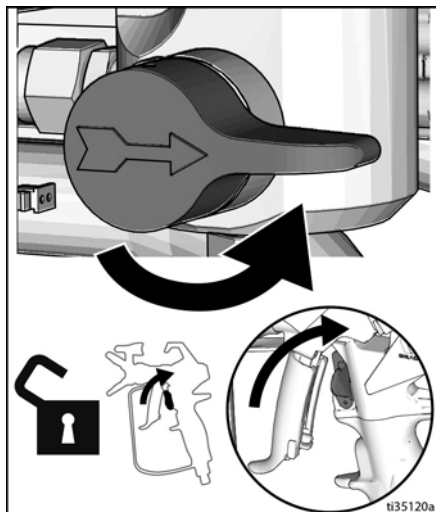

16. Hold a metal part of the gun firmly to a grounded metal pail. Trigger gun and flush until clean.
17. Turn ON/OFF switch to **OFF** position.
18. Engage trigger lock.
19. After flushing storage fluid out of the sprayer empty pail. Replace fluid intake with drain tube in grounded metal pail partially filled with flushing fluid. Use water to flush water-based paint or mineral spirits to flush oil-based paint.
20. Turn ON/OFF switch to **ON** position.
21. Turn prime valve horizontal. Disengage trigger lock.
22. Hold a metal part of the gun firmly to a grounded metal pail. Trigger gun and flush for one minute.
23. Turn ON/OFF switch to **OFF** position.
24. Engage trigger lock.
25. Sprayer is now ready to start up and spray.



## Startup

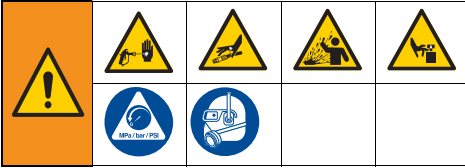

1. Perform **Pressure Relief Procedure**, page 12.
2. Turn pressure control to lowest pressure.

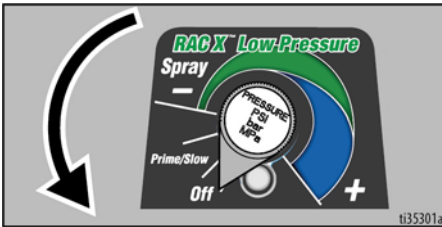

3. Turn ON/OFF switch to **ON** position.

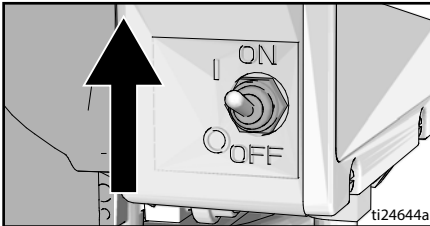

4. Place fluid intake in paint pail. Place drain tube in waste pail.

5. Increase pressure 1/2 turn to start motor. Allow paint to circulate through sprayer until paint flows out the drain tube.

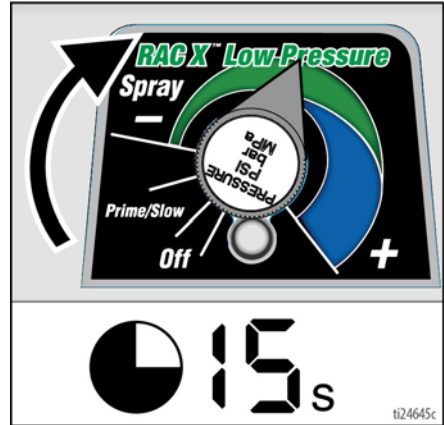

6. Turn prime valve horizontal. Disengage trigger lock.

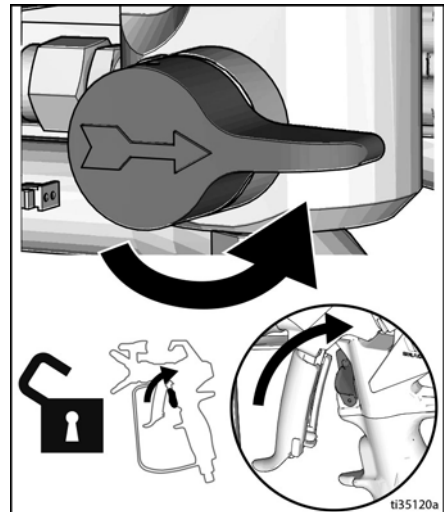

# Startup

7. Hold gun against grounded metal waste pail. Trigger gun until paint appears.

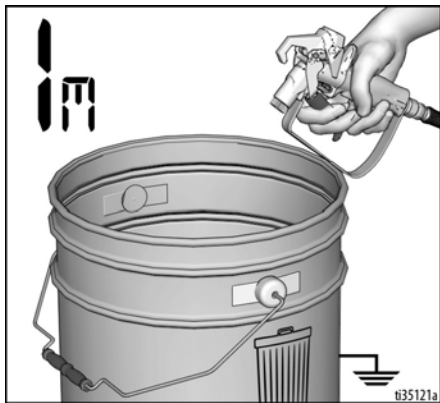

8. Move gun to paint pail and trigger for 20 seconds. Release trigger and allow sprayer to build pressure. Engage trigger lock.



High-pressure spray is able to inject toxins into the body and cause serious bodily injury. Do not stop leaks with hand or rag.

9. Inspect for leaks. If leaks occur, perform **Pressure Relief Procedure**, page 12, then tighten all fittings and repeat Startup procedure. If there are no leaks continue with the next step.
10. Screw tip assembly onto gun and tighten. See **Spray Tip Installation**, page 19. For gun assembly instructions, see separate gun manual.

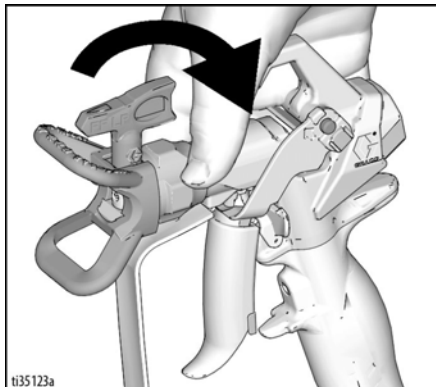

## Operation

### Spray Tip Installation



1. Perform **Pressure Relief Procedure**, page 12.
2. Use spray tip (A) to insert OneSeal™ (B) into tip guard (C).

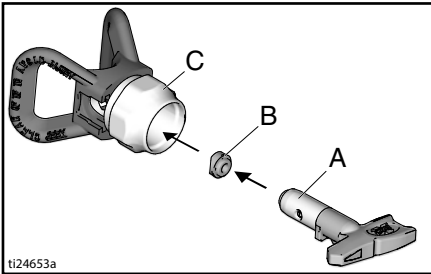

2. Insert Spray Tip.

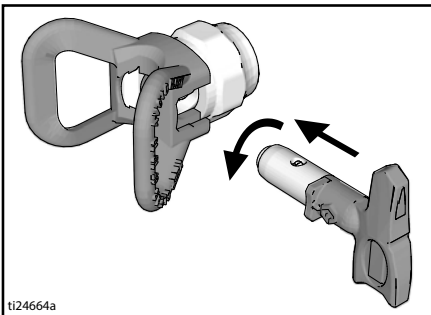

3. Screw assembly onto gun. Tighten.

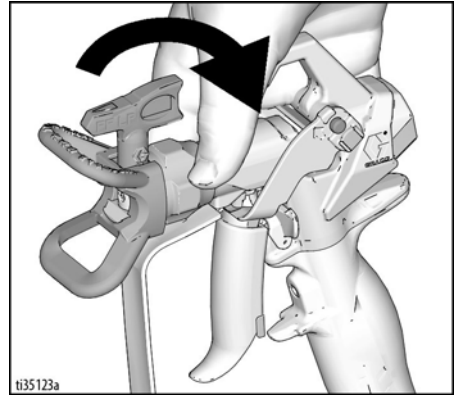

### Spray

1. Turn pressure control knob to **SPRAY** position.



2. Disengage Trigger Lock.



# Operation

## Adjust Pressure Control

1. For best spray results with lowest overspray, begin with the Pressure Control Knob adjusted to the lowest spray setting.
2. If needed, increase Pressure Control Knob setting to the lowest spray setting that results in an acceptable spray pattern.



## Spray Pattern Quality

A good spray pattern is evenly distributed as it hits the surface.

- Spray should be atomized (evenly distributed, no gaps at edges).
- Increase Pressure Control Knob if needed until spray is even and without gaps at edges.
- Spray Tip may be worn or a smaller tip may be needed.
- Material may need to be thinned. If material needs to be thinned follow manufacturer's recommendations.

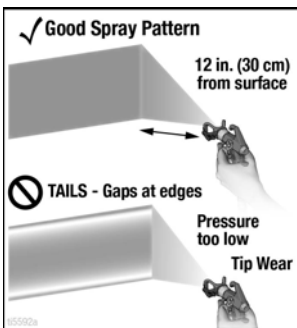

## Spray Techniques

Use a piece of scrap cardboard to practice these basic spraying techniques before you begin spraying the surface.

- Hold Spray Gun 12 in. (30 cm) from surface and aim straight at surface. Tilting Spray Gun to direct spray angle causes an uneven finish.
- Flex wrist to keep Spray Gun pointed straight. Fanning Spray Gun to direct spray at angle causes uneven finish.

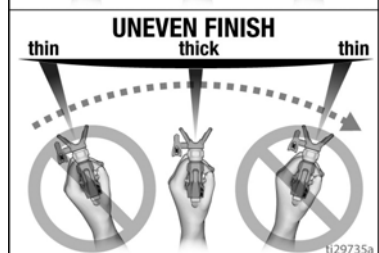
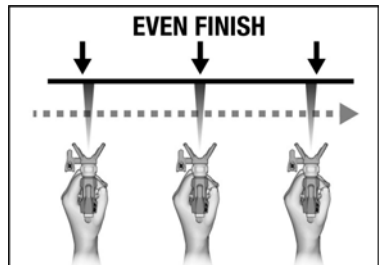
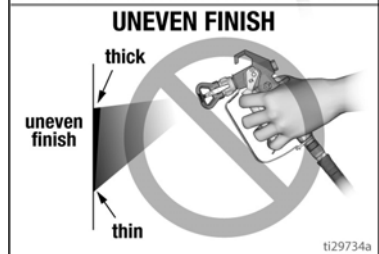
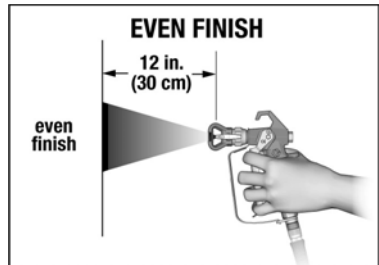

## Triggering Spray Gun

Pull trigger after starting stroke. Release trigger before end of stroke. Spray Gun must be moving when trigger is pulled and released.

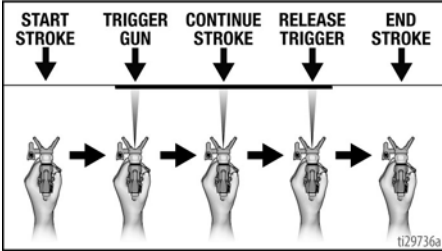

## Aiming Spray Gun

Aim center of spray of Spray Gun at bottom edge of previous stroke, overlapping each stroke by half.

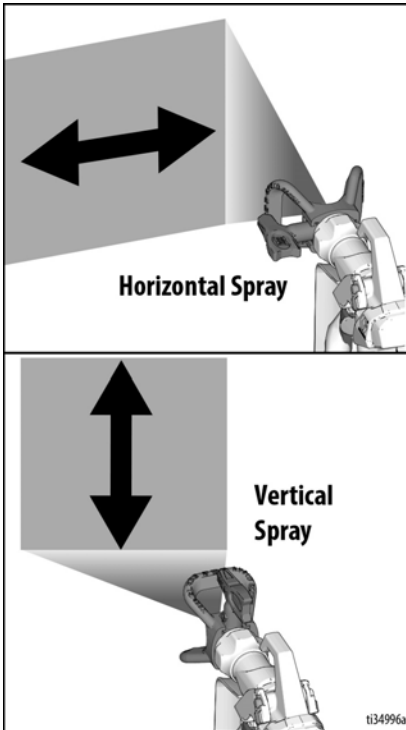

## Clear Spray Tip Clog



1. Release trigger. Engage trigger lock. Rotate Spray Tip. Disengage trigger lock. Trigger gun at waste area to clear clog.

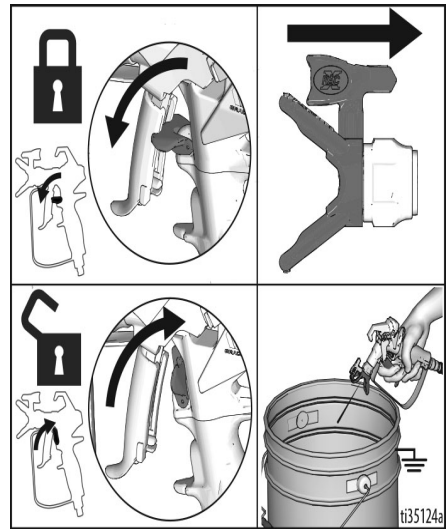

2. Engage trigger lock. Return Spray Tip to original position. Disengage trigger lock and continue spraying.

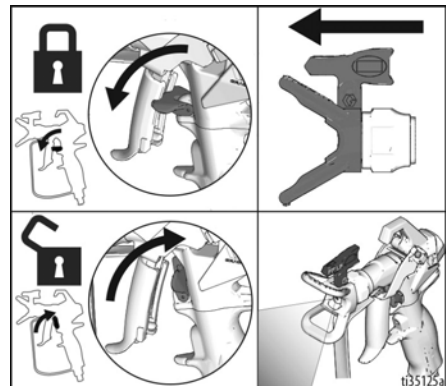

# Operation

## Digital Display

Some models are equipped with a digital display. This section explains how to use this feature.



## Pressure Display

1. Perform **Pressure Relief Procedure**, page 12.
2. Plug sprayer into grounded outlet. Turn ON/OFF switch to **ON** position.

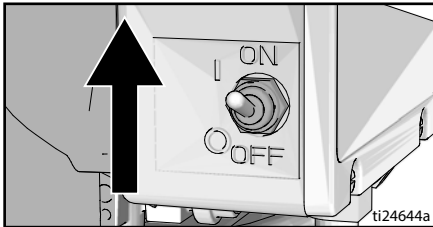
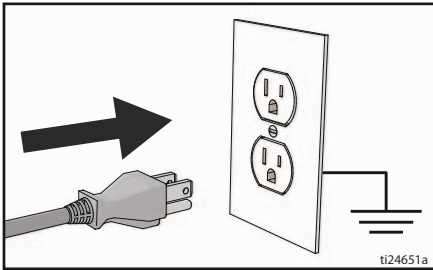

3. The pressure is displayed. Dashes indicate pressure is less than 200 psi (14 bar, 1.4 MPa).



4. Press and hold display button to change pressure units (psi, bar, or MPa).



## Stored Data Display

1. Turn ON/OFF switch to **OFF** position.

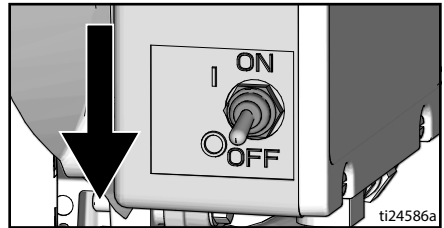

2. To enter Stored Data Mode, press and hold display button and turn ON/OFF switch to **ON** position.

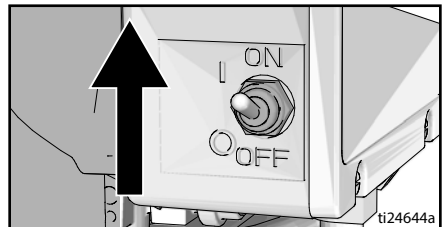

3. Sprayer model number is displayed followed by Data Point 1 which is the unit power on time in hours.



4. Press display button again to display Data Point 2. Motor run time in hours is displayed.



5. Press display button again to display Data Point 3. This will be the last error code.



ti2824a

6. To erase last error code, press and hold display button.
7. Press display button again to display Data Point 4. The software revision is displayed.



8. Press display button again to return to Data Point 1.



9. Turn ON/OFF switch to OFF position to exit Stored Data.

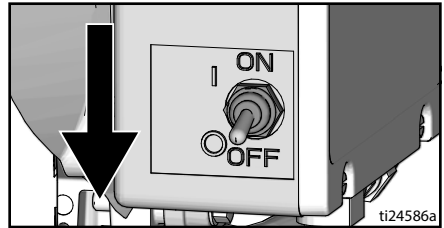

# Cleanup

## Cleanup



1. Perform **Pressure Relief Procedure**, page 12.
2. Remove tip guard and Spray Tip. For additional information, see separate gun manual.

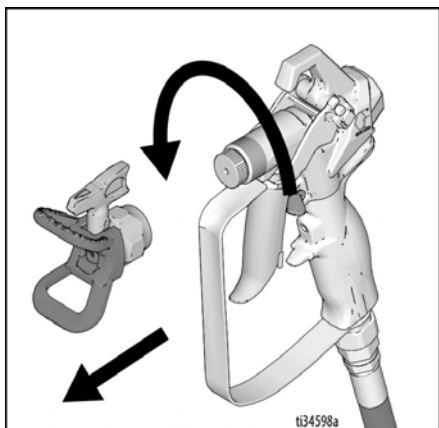

3. Remove fluid intake and drain tube from paint, wipe excess paint off outside.

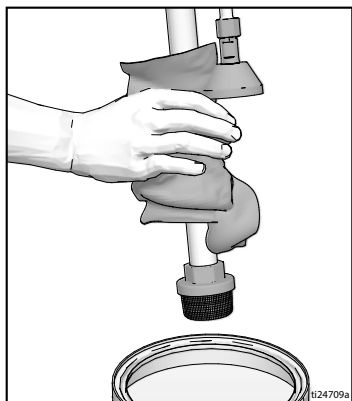

4. Place fluid intake in flushing fluid. Use water for water base paint and mineral spirits for oil-based paint. Place drain tube in waste pail.

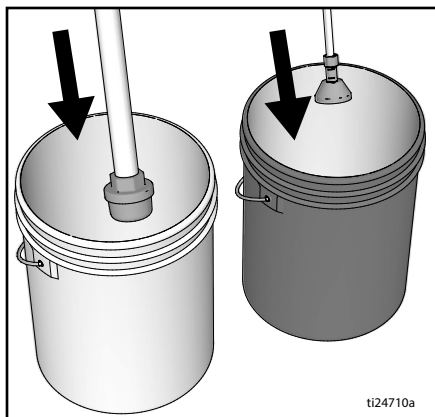

5. Turn prime valve horizontal.
6. Increase pressure 1/2 turn to start motor. Hold gun against paint pail. Disengage trigger lock. Trigger gun and increase pressure until the pump runs steady and flushing fluid appears.

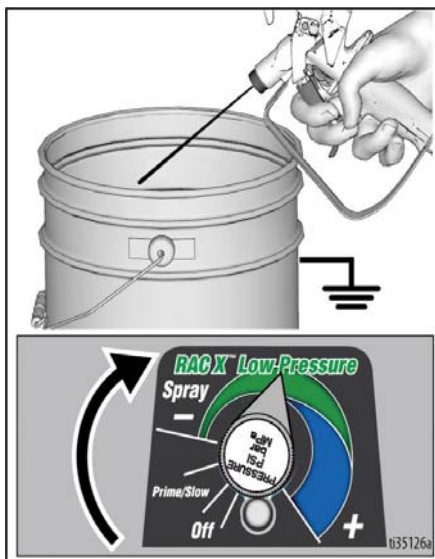



7. Stop triggering gun. Move gun to waste pail, hold gun against pail, trigger gun to thoroughly flush system.
8. While continuing to trigger gun, turn prime valve down. Then, release gun trigger. Allow flushing fluid to circulate until fluid comes out of drain tube clear.

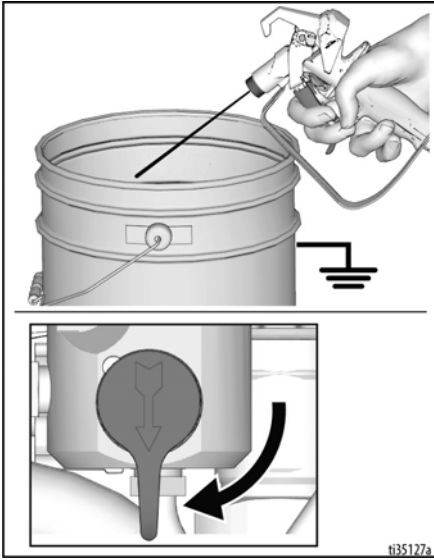

9. Raise fluid intake above flushing fluid.

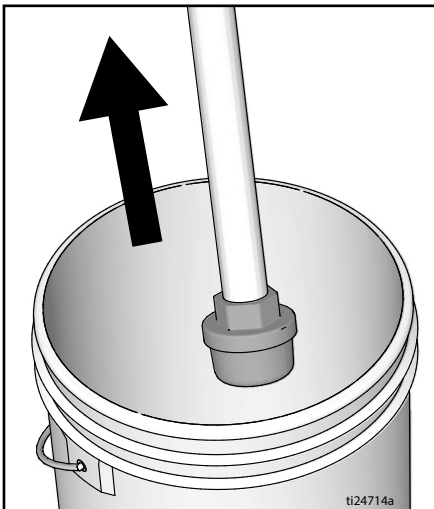

10. Turn prime valve horizontal. Trigger gun into flushing pail to purge fluid from hose.
11. Engage trigger lock.

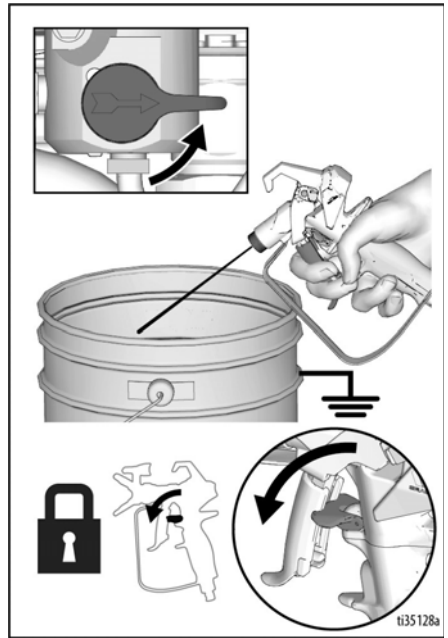

12. Turn pressure control knob to the lowest pressure setting and turn ON/OFF switch to **OFF** position. Disconnect power to sprayer.



# Cleanup

13. Remove filter from gun and sprayer if installed. Clean and inspect. Install filter. See separate gun manual.

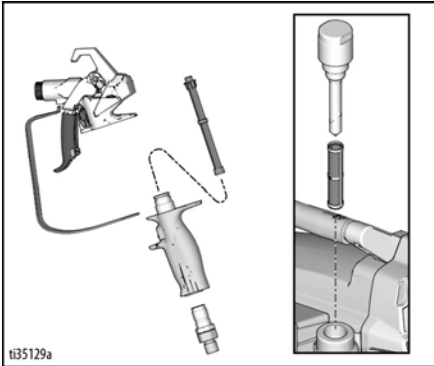

14. If flushing with water, flush again with mineral spirits or Pump Armor to leave a protective coating to prevent freezing or corrosion.

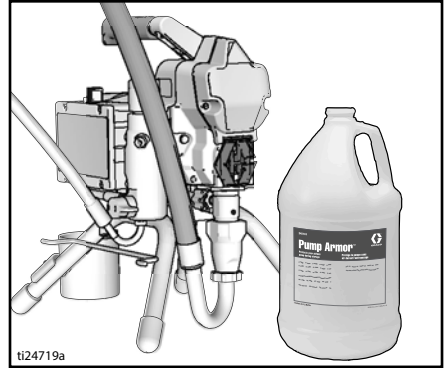

15. Wipe sprayer, hose and gun with a rag soaked in water or mineral spirits.

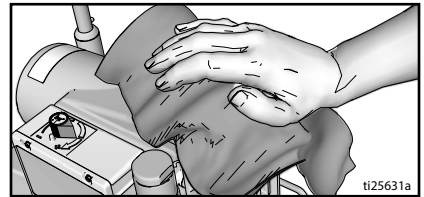

## Maintenance

Routine maintenance is important to ensure proper operation of your sprayer. Maintenance includes performing routine actions which keep your sprayer in operation and prevents trouble in the future.



Perform **Pressure Relief Procedure**, page 12, before performing maintenance.

| Activity   | Interval                         |
|--|----------------------------------|
| Inspect/clean sprayer filter, fluid inlet strainer, and gun filter.  | Daily or each time you spray     |
| Inspect motor shield vents for blockage.   | Daily or each time you spray     |
| Fill TSL by adding through TSL fill point.   | Daily or each time you spray     |
| Inspect motor brushes for wear. Brushes must be 1/2 in. (13mm) minimum length. NOTE: Brushes do not wear at the same rate on both sides of motor. Check both brushes.  | Every 1000 gallons (3785 liters) |
| <p>Check sprayer stall.</p> <p>With sprayer gun NOT triggered, sprayer motor should stall and not restart until gun is triggered again.</p> <p>If sprayer starts again with gun NOT triggered, inspect pump for internal/external leaks and check prime valve for leaks.</p>                             | Every 1000 gallons (3785 liters) |
| <p>Throat packing adjustment</p> <p>When pump packing begins to leak after extended use, tighten packing nut down until leakage stops or lessens. This allows approximately 100 gallons of additional operation before a repacking is required. Packing nut can be tightened without O-ring removal.</p> | As necessary based on usage      |

## Recycling and Disposal at End of Life

At the end of the product's useful life, dismantle and recycle it in a responsible manner.

### Preparation:

- Perform the **Pressure Relief Procedure**, page 12.
- Drain and dispose of fluids according to applicable regulations. Refer to the material manufacturer's Safety Data Sheet.

### Dismantle and recycle:

- Remove motors, circuit boards, displays, and other electronic components. Recycle according to applicable regulations.
- Do not dispose of electronic components with household or commercial waste.
- Deliver remaining product to a recycling facility.

## Troubleshooting

### Mechanical/Fluid Flow



1. Follow **Pressure Relief Procedure**, page 12, before checking or repairing.
2. Check all possible problems and causes before disassembling the unit.

| Problem   | What to Check<br>If check is OK, go to next check  | What to Do<br>When check is not OK,<br>refer to this column  |
|---|--|--|
| Control board status light is blinking or the light is off and there is power to the sprayer. | Fault condition exists.  | Determine fault correction from <b>Electrical</b> , page 31.   |
| Pump output is low  | Spray tip worn.  | Follow <b>Pressure Relief Procedure</b> , page 12, then replace tip. See separate gun or tip manual.   |
|   | Spray tip clogged.   | Relieve pressure. Check and clean spray tip.   |
|   | Paint supply.  | Refill and reprime pump.   |
|   | Intake strainer clogged.   | Remove and clean, then reinstall.  |
|   | Intake valve ball and piston ball are not seating properly.  | Remove intake valve and clean. Check balls and seats for nicks; replace if necessary. See pump manual. Strain paint before using to remove particles that could clog pump. |
|   | Fluid filter or tip filter is clogged or dirty.  | Clean filter.  |
|   | Prime valve leaking.   | Follow <b>Pressure Relief Procedure</b> , page 12, then repair prime valve.  |
|   | Verify pump does not continue to stroke when gun trigger is released. (Prime valve not leaking.)   | Service pump. See pump manual.   |
| Leaking around throat packing nut which may indicate worn or damaged packings.                | Replace packings. See pump manual. Also check piston valve seat for hardened paint or nicks and replace if necessary. Tighten packing nut/wet-cup. |  |

| Problem                             | What to Check<br>If check is OK, go to next check   | What to Do<br>When check is not OK,<br>refer to this column   |
|-------------------------------------|---|---|
| Pump output is low                  | Pump rod damage.  | Repair pump. See pump manual.   |
|                                     | Low stall pressure.   | Turn pressure knob fully clockwise. Make sure pressure control knob is properly installed to allow full clockwise position. If problem persists, replace pressure transducer. |
|                                     | Piston packings are worn or damaged.  | Replace packings. See pump manual.  |
|                                     | O-ring in pump is worn or damaged.  | Replace o-ring. See pump manual.  |
|                                     | Intake valve ball is packed with material.  | Clean intake valve. See pump manual.  |
|                                     | Large pressure drop in hose with heavy materials.   | Reduce overall length of hose.  |
|                                     | Check extension cord for correct size.  | See <b>Extension Cords</b> , page 11.   |
|                                     | Loose motor brushes and terminals.  | Tighten terminal screws. Replace brushes if leads are damaged.  |
|                                     | Worn motor brushes. (Brushes must be 1/2 in. [13mm] minimum length).                                    | Replace brushes.  |
|                                     | Broken and misaligned motor brush springs. Rolled portion of spring must rest squarely on top of brush. | Replace spring if broken. Realign spring with brush.  |
|                                     | Motor brushes are binding in brush holders.   | Clean brush holders, remove carbon dust with a small cleaning brush. Align brush lead with slot in brush holder to assure free vertical brush movement.                       |
| Motor runs but pump does not stroke | Connecting rod assembly damaged. See pump manual.   | Replace connecting rod assembly. See pump manual.   |
|                                     | Gears or drive housing damaged.   | Inspect drive housing assembly and gears for damage and replace if necessary.   |

# Troubleshooting

| Problem   | What to Check<br>If check is OK, go to next check   | What to Do<br>When check is not OK,<br>refer to this column   |
|---|---|---|
| Excessive paint leakage into throat packing nut | Throat packing nut is loose.  | Remove throat packing nut spacer. Tighten throat packing nut just enough to stop leakage.                     |
|   | Throat packings are worn or damaged.  | Replace packings. See pump manual.  |
|   | Displacement rod is worn or damaged.  | Replace rod. See pump manual.   |
| Fluid is spitting from gun                      | Air in pump or hose.  | Check and tighten all fluid connections. Cycle pump as slowly as possible during priming.                     |
|   | Spray tip is partially clogged.   | Clear tip. See <b>Clear Spray Tip Clog</b> , page 21.   |
|   | Fluid supply is low or empty.   | Refill fluid supply. Prime pump. See pump manual. Check fluid supply often to prevent running pump dry.       |
| Pump is difficult to prime                      | Air in pump or hose.  | Check and tighten all fluid connections. Cycle pump as slowly as possible during priming.                     |
|   | Intake valve is leaking.  | Clean intake valve. Be sure ball seat is not nicked or worn and that ball seats well. Reassemble valve.       |
|   | Pump packings are worn.   | Replace pump packings. See pump manual.   |
|   | Paint is too thick.   | Thin the paint according to supplier recommendations.   |
| Sprayer operates for 5 to 10 minutes then stops | Pump packing nut too tight. When pump packing nut is too tight the packings on the pump rod restrict pump action and overloads the motor. | Loosen pump packing nut. Check for leaks around throat. If necessary, replace pump packings. See Pump manual. |

## Electrical

Symptom: Sprayer does not run, stops running, or will not shut off.



Perform **Pressure Relief Procedure**, page 12.

1. Plug sprayer into correct voltage, grounded outlet.
2. Turn the ON/OFF switch **OFF** wait 30 seconds and then turn power back **ON** again (this ensures sprayer is in normal run mode).
3. Turn pressure control knob clockwise 1/2 turn.

4. Remove control box cover to view control board status light. To determine which code refer to the control board status light. Turn the ON/OFF switch **OFF**, remove the control cover then turn power back **ON**. Observe the status light. Blinking LED total count equals the error code (for example: two blinks equals CODE 02).



Keep clear of electrical and moving parts during troubleshooting procedures. To avoid electrical shock hazards when covers are removed for troubleshooting, wait 7 seconds after disconnecting power cord for stored electricity to dissipate.

| Problem  | What to Check            | How to check           |
|--|--------------------------|------------------------|
| Sprayer does not run at all<br>AND<br>Control board status light never lights            | See flow chart, page 38. |                        |
| Sprayer does not shut off<br>AND<br>Control board status light blinks 2 times repeatedly | Control board.           | Replace control board. |

# Troubleshooting

| Problem   | What to Check   | How to check   |
|---|---|--|
| <p>Sprayer does not run at all<br/>AND<br/>Control board status light<br/>blinks 2 times repeatedly</p> | <p>Check transducer or<br/>transducer connections</p> | <p>Make sure there is no pressure in the system (see <b>Pressure Relief Procedure</b>, page 12). Check fluid path for clogs, such as clogged filter.</p> <p>Use airless paint spray hose with no metal braid. A small hose or metal braid hose may result in high-pressure spikes.</p> <p>Turn ON/OFF switch <b>OFF</b> and disconnect power to sprayer.</p> <p>Check transducer and connections to control board.</p> <p>Disconnect transducer from control board socket. Check that transducer and control board contacts are clean and secure.</p> <p>Reconnect transducer to control board socket. Connect power, turn ON/OFF switch <b>ON</b> and control knob 1/2 turn clockwise. If sprayer does not run properly, turn ON/OFF switch <b>OFF</b> and go to next step.</p> <p>Install new transducer. Connect power, turn ON/OFF switch <b>ON</b> and control knob 1/2 turn clockwise. Replace control board if sprayer does not run properly.</p> |



| Problem   | What to Check   | How to check  |
|---|---|---|
| <p>Sprayer does not run at all<br/>AND<br/>Control board status light blinks 3 times repeatedly</p> | <p>Check transducer or transducer connections (control board is not detecting a pressure signal).</p> | <p>Turn ON/OFF switch <b>OFF</b> and disconnect power to sprayer.</p> <p>Check transducer and connections to control board.</p> <p>Disconnect transducer from control board socket. Check to see if transducer and control board contacts are clean and secure.</p> <p>Reconnect transducer to control board socket. Connect power, turn ON/OFF switch <b>ON</b> and control knob to 1/2 turn clockwise. If sprayer does not run, turn ON/OFF switch <b>OFF</b> and go to next step.</p> <p>Connect a confirmed working transducer to control board socket.</p> <p>Turn ON/OFF switch <b>ON</b> and control knob to 1/2 turn clockwise. If sprayer runs, install new transducer. Replace control board if sprayer does not run.</p> |
| <p>Sprayer does not run at all<br/>AND<br/>Control board status light blinks 4 times repeatedly</p> | <p>Check voltage supply to the sprayer (control board is detecting a multiple voltage surges).</p>    | <p>Turn ON/OFF switch <b>OFF</b> and disconnect power to sprayer.</p> <p>Locate a good voltage supply to prevent damage to electronics.</p>   |

# Troubleshooting

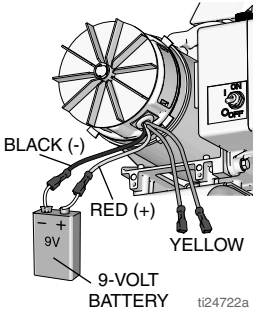
| Problem  | What to Check  | How to check  |
|--|--|---|
| <p>Sprayer does not run at all<br/> <b>AND</b><br/>           Control board status light blinks 5 times repeatedly</p> | <p>Control is commanding motor to run but motor shaft does not rotate. Possibly locked rotor condition, an open connection exists between motor and control, there is a problem with motor or control board, or motor amp draw is excessive.</p> | <ol style="list-style-type: none"> <li>1. Remove pump and try to run sprayer. If motor runs, check for locked or frozen pump or drive train. If sprayer does not run, continue to step 2.</li> <li>2. Turn ON/OFF switch <b>OFF</b> and disconnect power to sprayer.</li> <li>3. Disconnect motor connector(s) from control board socket(s). Check that motor connector and control board contacts are clean and secure. If contacts are clean and secure, continue to step 4.</li> <li>4. Connect a DC voltmeter across the two motor wires – red &amp; black spin the motor fan and check for a voltage to register on the meter. If voltage is not present, check brushes. If OK, replace motor. If voltage is present, go to step 5.</li> <li>5. Perform a spin test by connecting a 9 –12 Volt battery to the motor leads. Motor leads may vary in style and size. Locate the two wires going to the carbon brushes normally Red and Black. Motor should spin when battery is connected to the motor leads.</li> </ol> <div style="text-align: right; margin-top: 20px;">  <p>ti24722a</p> </div> |

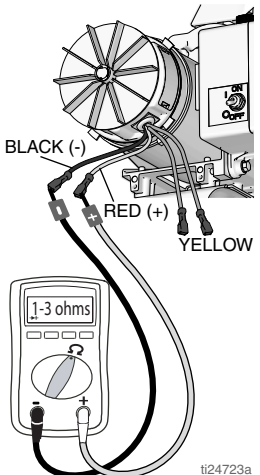
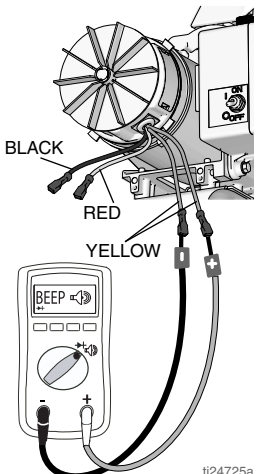
| Problem | What to Check | How to check  |
|---------|---------------|---|
|         |               | <p data-bbox="718 194 1026 332">6. Connect the Red and Black leads from the motor to an Ohm meter. Rotate the motor while checking for opens. If an open is found replace the motor.</p>  <p data-bbox="941 820 1000 836">ti24723a</p> <p data-bbox="718 852 1026 1031">7. Check motor thermal protection. Motor should be at ambient temperature for this test. Connect the yellow leads from the motor to an Ohm meter. Meter should indicate continuity or OHms depending on the motor type.</p>  <p data-bbox="941 1518 1000 1534">ti24725a</p> |

# Troubleshooting

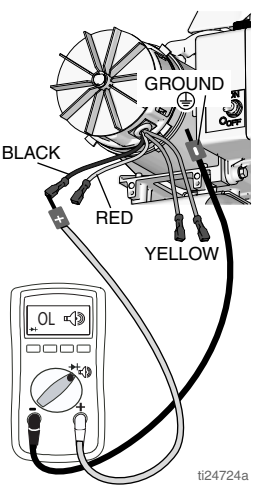
| Problem   | What to Check  | How to check  |
|---|--|---|
|   |  | <p>8. Use an Ohm meter to check motor for shorts. Connect (-) meter lead to motor case. Move the (+) meter lead to each motor wire. Meter should read open on all wires.</p>  <p>ti24724a</p> <p>9. Reconnect motor connector(s) to control board socket(s). Connect power, turn ON/OFF switch <b>ON</b> and control knob to 1/2 turn clockwise. If motor does not run, replace control board.</p> |
| <p>Sprayer does not run at all<br/>AND<br/>Control board status light blinks 6 times repeatedly</p> | <p>Motor is hot or there is a fault in the motor thermal device.</p>                         | <p>Allow sprayer to cool. If sprayer runs when cool, correct cause of overheating. Keep sprayer in cooler location with good ventilation. Make sure motor air intake is not blocked. If sprayer still does not run, replace motor.</p>  |
| <p>Sprayer does not run at all<br/>AND<br/>Control board status light blinks 8 times repeatedly</p> | <p>Check voltage supply to the sprayer (incoming voltage too low for sprayer operation).</p> | <p>Turn ON/OFF switch OFF and disconnect power to the sprayer.</p>  |

| <b>Problem</b>            | <b>What to Check</b>   | <b>How to check</b>   |
|---------------------------|--|---|
| Basic electrical problems | Motor leads are securely fastened and properly mated   | Replace loose terminals; crimp to leads. Be sure terminal are firmly connected.<br>Clean circuit board terminals. Securely reconnect leads.       |
|                           | For loose motor brush lead connections and terminals.  | Tighten terminal screws. Replace brushes if leads are damaged.  |
|                           | Brushes must be 1/2 in. [13mm] minimum. NOTE: Brushes do not wear at the same rate on both sides of motor. Check both brushes. | Replace brushes.  |
|                           | Broken or misaligned motor brush springs. Rolled portion of spring must rest squarely on top of brush.                         | Replace spring if broken. Realign spring with brush.  |
|                           | Motor brushes may be binding in brush holders.   | Clean brush holders. Remove carbon with small cleaning brush. Align brush leads with slot in brush holder to assure free vertical brush movement. |
|                           | Motor armature commutator for burn spots, gouges or extreme roughness.   | Remove motor and have motor shop resurface commutator if possible.  |

# Troubleshooting

## Sprayer Will Not Run

(See following page for steps)

### Sprayer Will Not Run

(see following pages for steps)

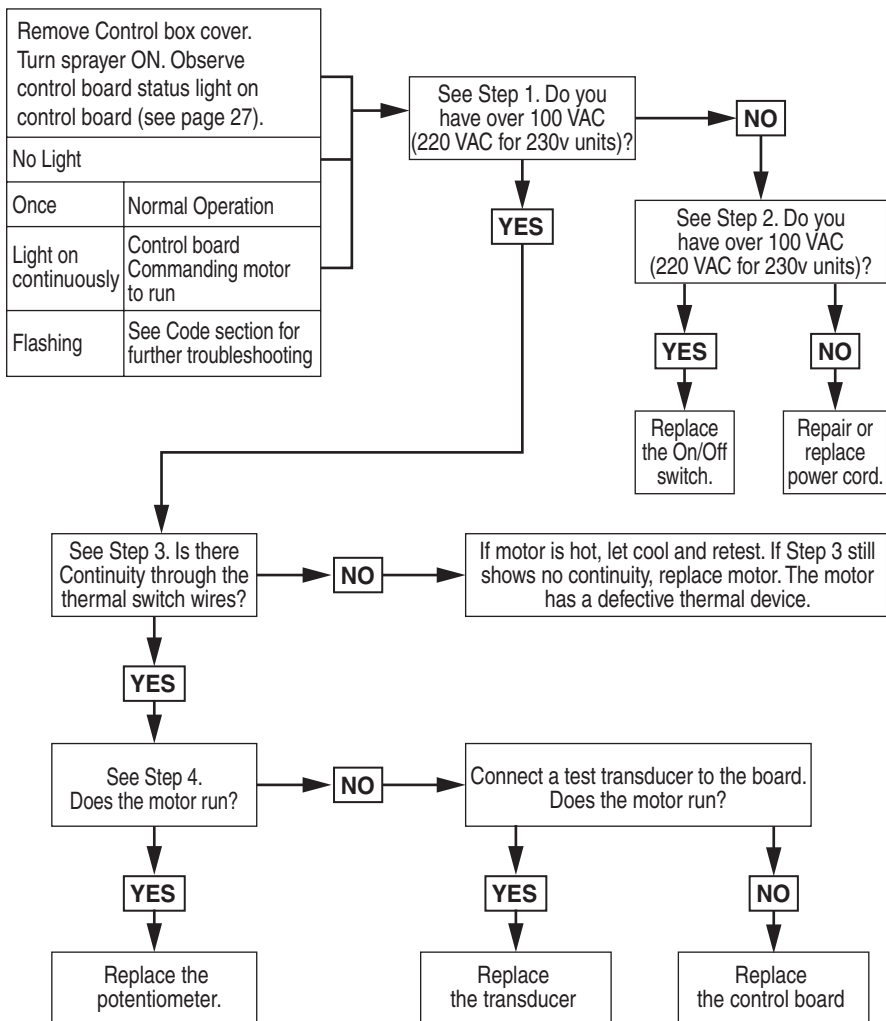

t124726a

## Step 1:

Plug Power cord in and turn switch ON. Connect probes to L and N on control board. Turn meter to AC Volts.

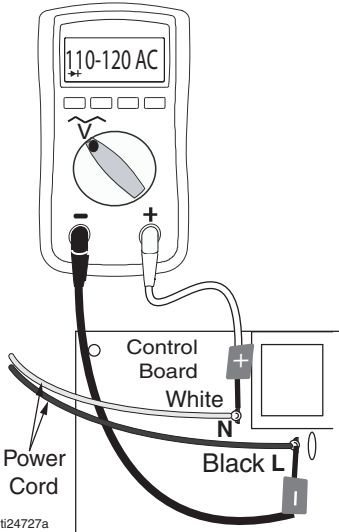

## Step 2:

Plug power cord in and turn switch ON. Connect Probes to ON/OFF switch. Turn meter to AC Volts.

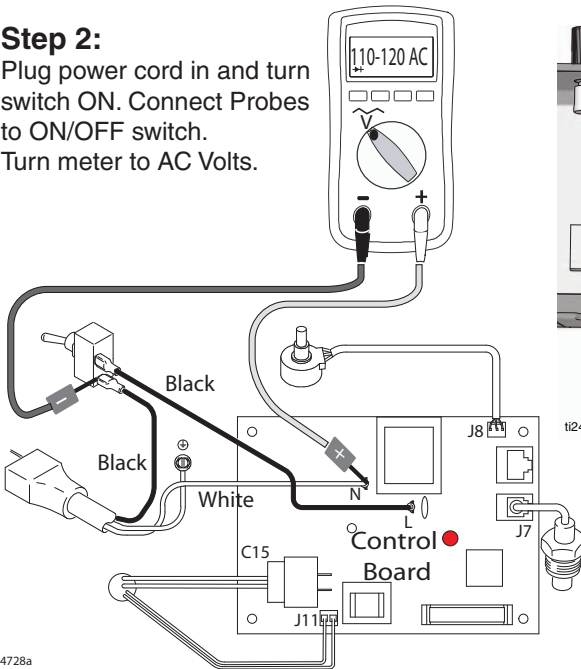

## Step 3:

Check motor thermal switch. Unplug yellow wires. Meter should read continuity.

**NOTE:** Motor should be cool during reading.

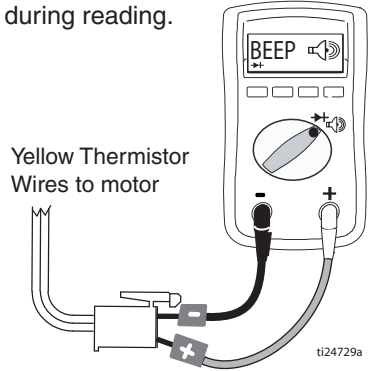

## Step 4:

Disconnect potentiometer. Plug power cord in and turn switch ON.

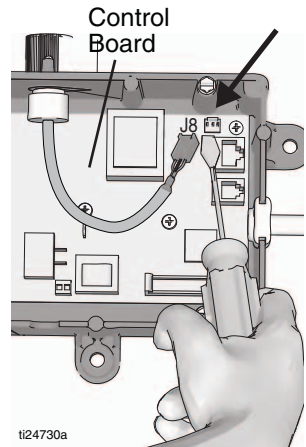

# Troubleshooting

## Sprayer Will Not Shut Off

1. Perform **Pressure Relief Procedure**, page 12. Leave prime valve open (down) and turn ON/OFF switch **OFF**.

2. Remove control box cover so the control board status light can be viewed if available.

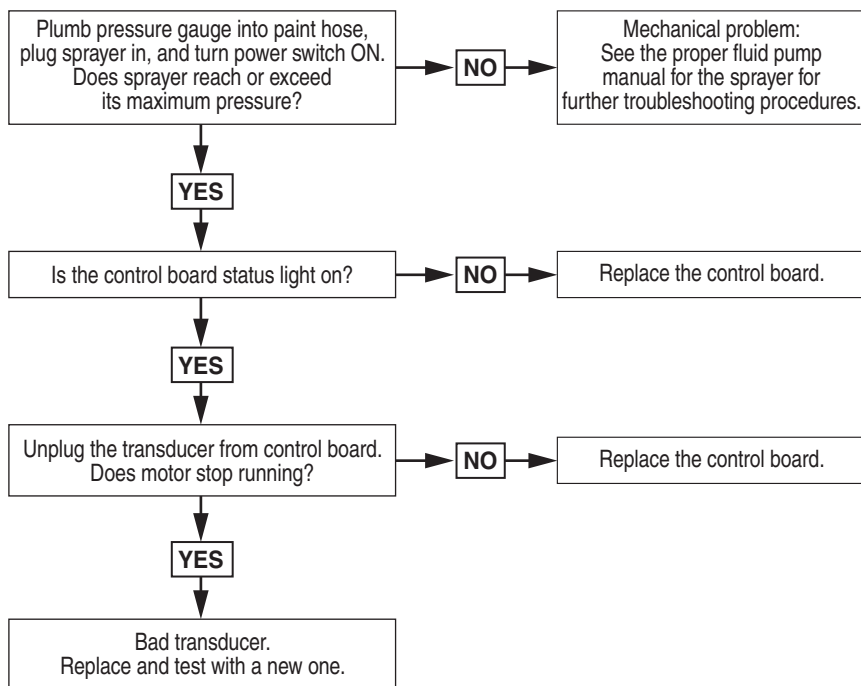

## Troubleshooting Procedure



ti24731a





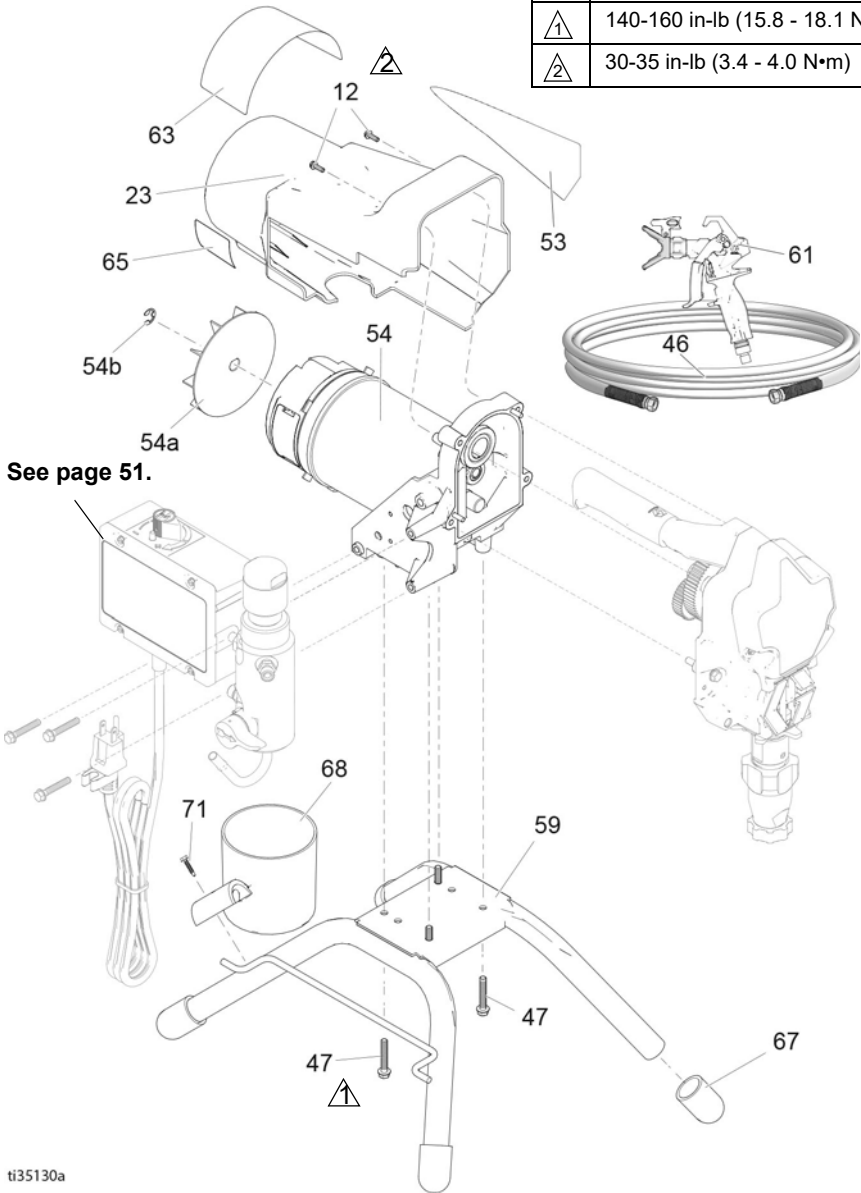

## Stand Sprayers

| Ref.  | Torque                          |
|---|---------------------------------|
|  | 140-160 in-lb (15.8 - 18.1 N•m) |
|  | 30-35 in-lb (3.4 - 4.0 N•m)     |



ti35130a

# Stand Sprayers

| Ref.  | Torque                          |
|---|---------------------------------|
|  | 140-160 in-lb (15.8 - 18.1 N•m) |
|  | 30-35 in-lb (3.4 - 4.0 N•m)     |
|  | Hammer tight                    |
|  | 25-30 ft-lb (33.9 - 40.7 N•m)   |

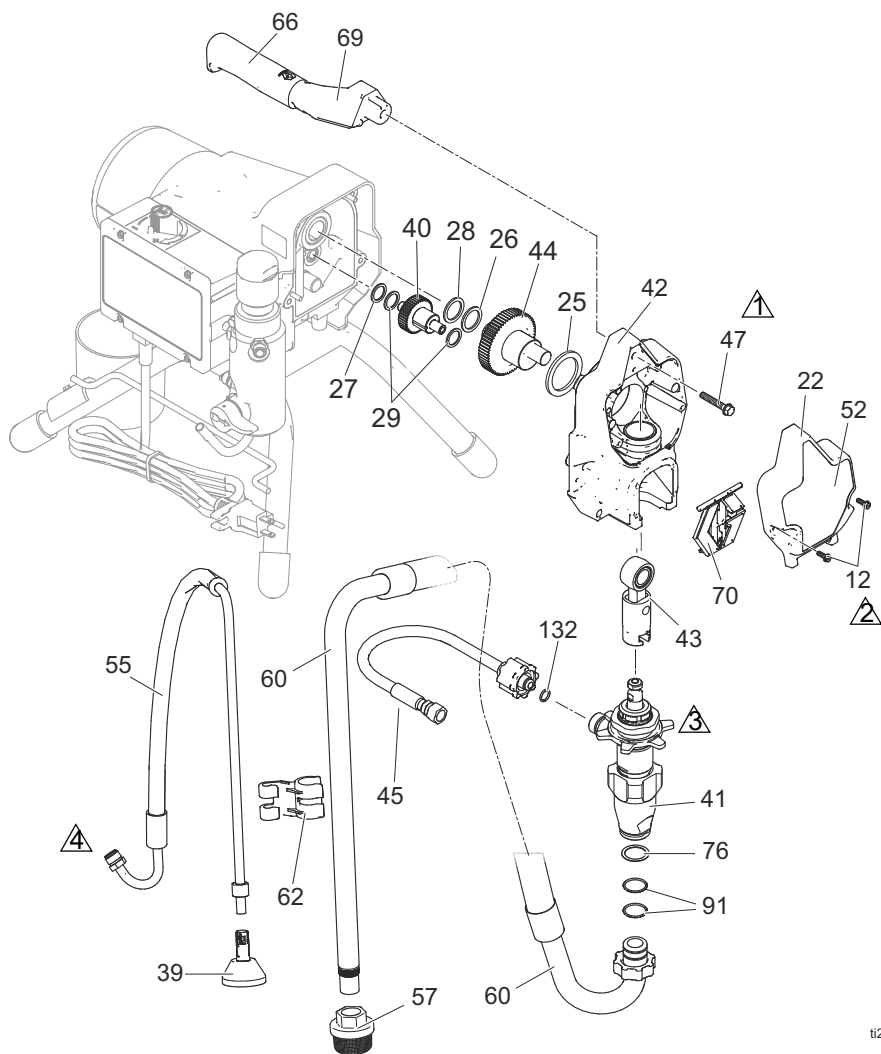

ti24753a

## Stand Sprayers Parts List



| Ref. | Part        | Description                              | Qty. | Ref.   | Part                          | Description                                       | Qty. |
|------|-------------|--|------|--------|-------------------------------|---|------|
| 12   | 117501      | SCREW, mach, hex washer hd               | 4    |        | 287015                        | 110V / 120V                                       |      |
|      |             |  |      |        | 287060                        | 230V  |      |
| 22   | 17C539      | COVER, front, painted                    | 1    | 54a    | 118716                        | RING, retaining                                   | 1    |
| 23   | 15B465      | SHIELD, motor, painted                   | 1    | 54b    | 248189                        | FAN, motor, <i>includes 54a</i>                   | 1    |
| 25   | 180131      | BEARING, thrust                          | 1    | 55     | 246381                        | HOSE, drain, stand, <i>includes 39,62</i>         | 1    |
| 26   | 107434      | BEARING, thrust                          | 1    | 57     | 246385                        | STRAINER, 7/8-14 unf                              | 1    |
| 27   | 116073      | WASHER, thrust                           | 1    | 59     | 15E823                        | FRAME, standmount, <i>includes 67</i>             | 1    |
| 28   | 116074      | WASHER, thrust                           | 1    | 60     | 246386                        | KIT, hose suction, <i>includes 57, 62, 76, 91</i> | 1    |
| 29   | 116079      | BEARING, thrust                          | 2    |        |                               |   |      |
| 33   | 206994      | FLUID, TSL (not shown)                   | 1    | 61     | See page 50                   | GUN, spray  | 1    |
| 34▲  | See page 50 | CARD, medical alert (not shown)          | 1    | 62     | 276888                        | CLIP, drain line                                  | 1    |
| 39   | 241920      | DEFLECTOR, threaded                      | 1    | 63▲    | See page 50                   | LABEL, danger                                     | 1    |
| 40   | 249194      | GEAR, reducer                            | 1    | 65▲    | See page 50                   | LABEL, warning                                    | 1    |
| 41   |             | PUMP, displacement, PC                   | 1    | 66     | 116139                        | GRIP, handle                                      | 1    |
|      | 17C487      | North America                            |      | 67     | 15G857                        | CAP, leg  | 4    |
|      | 17C488      | Asia/ANZ/Japan                           |      | 68     | 287903                        | CUP, suction/drain                                | 1    |
| 42   | 24W817      | HOUSING, drive, PC, <i>includes 47</i>   | 1    | 69     | 287072                        | HANDLE, sprayer, <i>includes 47, 66</i>           | 1    |
| 43   | 24W640      | ROD, connecting, PC                      | 1    | 70     | 17C483                        | COVER, pump rod                                   | 1    |
| 44   | 24X020      | GEAR, crankshaft, <i>includes 25</i>     | 1    | 71     | 122667                        | SCREW, drill, hex washer head                     | 1    |
| 45   | 24W830      | KIT, hose, cpld, PC, <i>includes 132</i> | 1    | 76     | 115099                        | WASHER, hose                                      | 1    |
| 46   | See page 50 | HOSE, cpld, 1/4 in. x 50 ft              | 1    | 91     | 117559                        | O-ring  | 2    |
| 47   | 117493      | SCREW, mach, hex washer hd               | 9    | 132    | 16H137                        | PACKING, O-ring                                   | 1    |
| 52   | See page 50 | LABEL, front                             | 1    | 206994 | FLUID, TSL, 8 oz. (not shown) |   | 1    |
| 53   | See page 50 | LABEL, side                              | 1    |        |                               |   |      |
| 54*  |             | MOTOR, <i>includes 54a, 54b</i>          | 1    |        |                               |   |      |

\* For motor brush kit order 287735

▲ Replacement safety labels, tags, and cards are available at no cost.



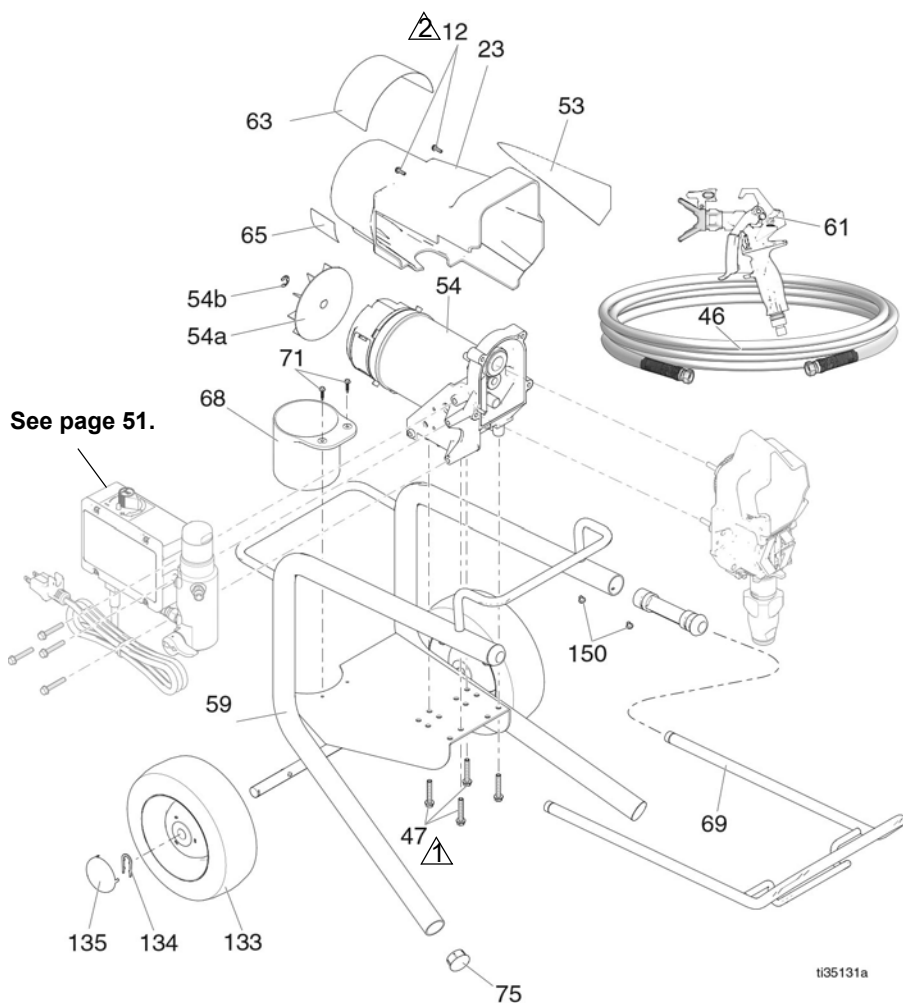

# 395 Lo-Boy Sprayers

## 395 Lo-Boy Sprayers

| Ref.  | Torque                          |
|---|---------------------------------|
|  1 | 140-160 in-lb (15.8 - 18.1 N•m) |
|  2 | 30-35 in-lb (3.4 - 4.0 N•m)     |



# 395 Lo-Boy Sprayers

| Ref.  | Torque                          |
|---|---------------------------------|
|  1 | 140-160 in-lb (15.8 - 18.1 N•m) |
|  2 | 30-35 in-lb (3.4 - 4.0 N•m)     |
|  3 | Hammer tight                    |
|  4 | 25-30 ft-lb (33.9 - 40.7 N•m)   |

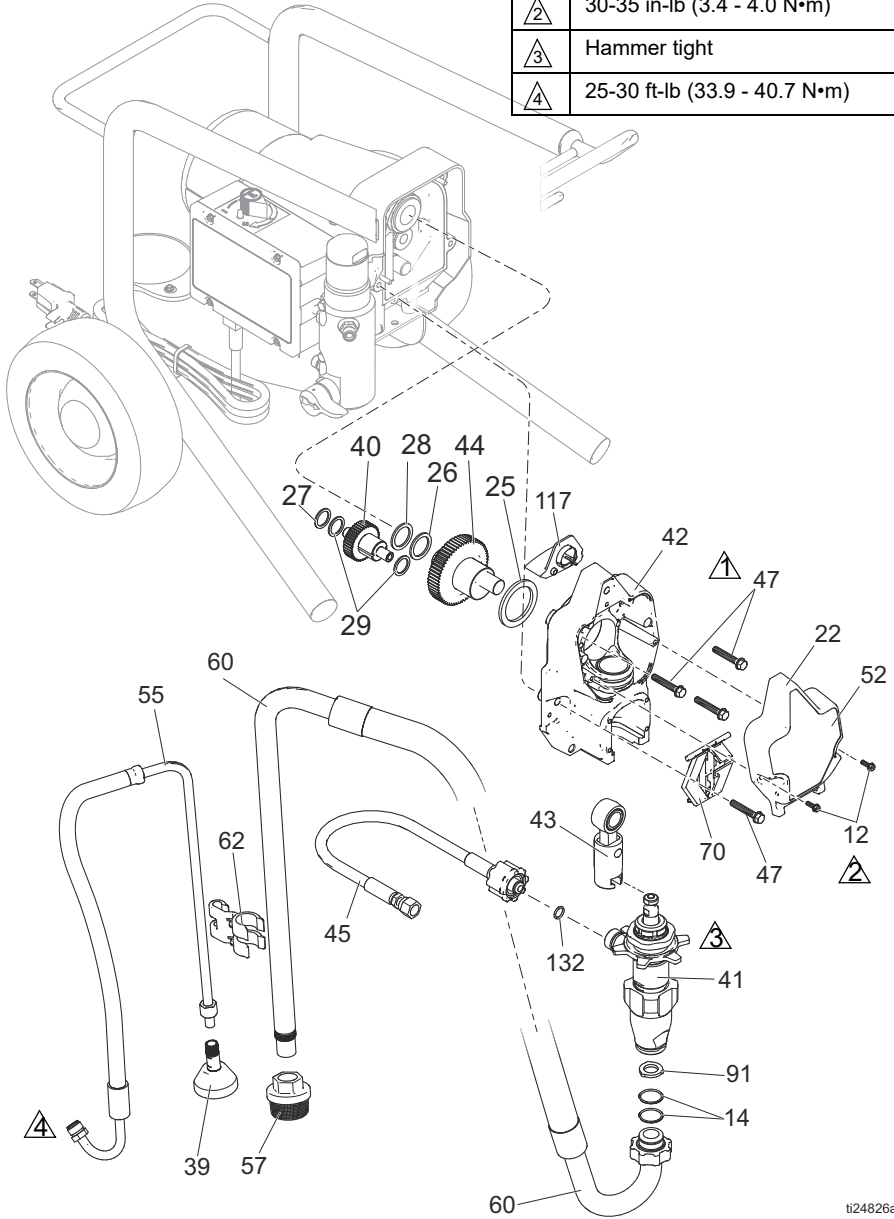

ti24826a

# 395 Lo-Boy Sprayers

## 395 Lo-Boy Sprayers Parts List

| Ref. Part | Description                                     | Qty. | Ref. Part | Description  | Qty. |
|-----------|---|------|-----------|--|------|
| 12        | 117501 SCREW, mach, hex washer hd               | 4    | 54a       | 118716 RING, retaining                                   | 1    |
| 14        | 117559 O-ring                                   | 2    | 54b       | 248189 FAN, motor, <i>includes 54a</i>                   | 1    |
| 22        | 17C539 COVER, front, painted                    | 1    | 55        | 246381 HOSE, drain, stand, <i>includes 39,62</i>         | 1    |
| 23        | 15B465 KIT, shield, motor, painted              | 1    | 57        | 246385 STRAINER, 7/8-14 unf                              | 1    |
| 25        | 180131 BEARING, thrust                          | 1    | 59        | 246250 FRAME, cart, lo                                   | 1    |
| 26        | 107434 BEARING, thrust                          | 1    | 60        | 246386 KIT, hose suction, <i>includes 14, 57, 62, 91</i> | 1    |
| 27        | 116073 WASHER, thrust                           | 1    | 61        | See page 50 GUN, spray (not shown)                       | 1    |
| 28        | 116074 WASHER, thrust                           | 1    | 62        | 276888 CLIP, drain line                                  | 1    |
| 29        | 116079 BEARING, thrust                          | 2    | 63▲       | See page 50 LABEL, danger                                | 1    |
| 33        | 206994 FLUID, TSL (not shown)                   | 1    | 65▲       | See page 50 LABEL, warning                               | 1    |
| 34▲       | See page 50 CARD, medical alert (not shown)     | 1    | 68        | 15B870 CUP, suction/drain                                | 1    |
| 39        | 241920 DEFLECTOR, threaded                      | 1    | 69        | 287488 HANDLE, assembly, lo cart                         | 1    |
| 40        | 249194 GEAR, reducer                            | 1    | 70        | 17C483 COVER, pump rod                                   | 1    |
| 41        | 17C487 PUMP, displacement, PC, North America    | 1    | 71        | 122667 SCREW, drill, hex washer head                     | 2    |
| 42        | 24W817 HOUSING, drive, PC, <i>includes 47</i>   | 1    | 75        | 107310 PLUG, tubing                                      | 2    |
| 43        | 24W640 ROD, connecting, PC                      | 1    | 91        | 115099 WASHER, hose                                      | 1    |
| 44        | 24X020 GEAR, crankshaft, <i>includes 25</i>     | 1    | 117       | 15G447 PLUG, shield, painted                             | 1    |
| 45        | 24W830 KIT, hose, cpld, PC, <i>includes 132</i> | 1    | 132       | 16H137 PACKING, O-ring                                   | 1    |
| 46        | See page 50 HOSE, cpld, 1/4 in. x 50 ft         | 1    | 133       | 195766 WHEEL, semi pneumatic                             | 2    |
| 47        | 117493 SCREW, mach, hex washer hd               | 8    | 134       | 15B999 CLIP, retaining                                   | 2    |
| 52        | See page 50 LABEL, front                        | 1    | 135       | 104811 CAP, hub  | 2    |
| 53        | See page 50 LABEL, side                         | 1    | 150       | 109032 SCREW, pan hd                                     | 4    |
| 54*       | 287015 MOTOR, <i>includes 54a, 54b</i>          | 1    | 206994    | FLUID, TSL, 8 oz. (not shown)                            | 1    |

\* For motor brush kit order 287735  
 ▲Replacement safety labels, tags, and cards are available at no cost.

## Hi-Boy Sprayers

| Ref. | Torque                          |
|------|---------------------------------|
| ①    | 140-160 in-lb (15.8 - 18.1 N•m) |
| ②    | 30-35 in-lb (3.4 - 4.0 N•m)     |
| ③    | 23-27 in-lb (2.6 - 3.1 N•m)     |

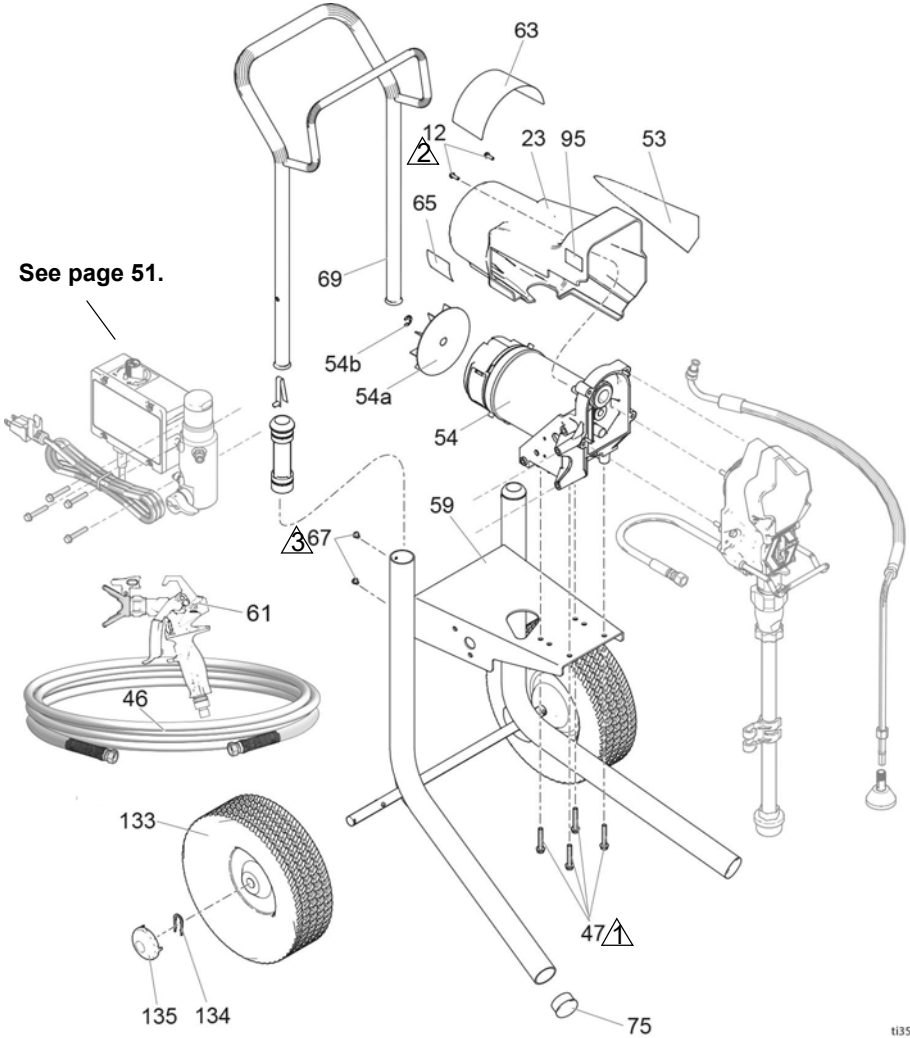

t135132a

# Hi-Boy Sprayers

| Ref. | Torque                          |
|------|---------------------------------|
| ①    | 140-160 in-lb (15.8 - 18.1 N•m) |
| ②    | 30-35 in-lb (3.4 - 4.0 N•m)     |
| ③    | Hammer tight                    |
| ④    | 25-30 ft-lb (33.8 - 40.6 N•m)   |

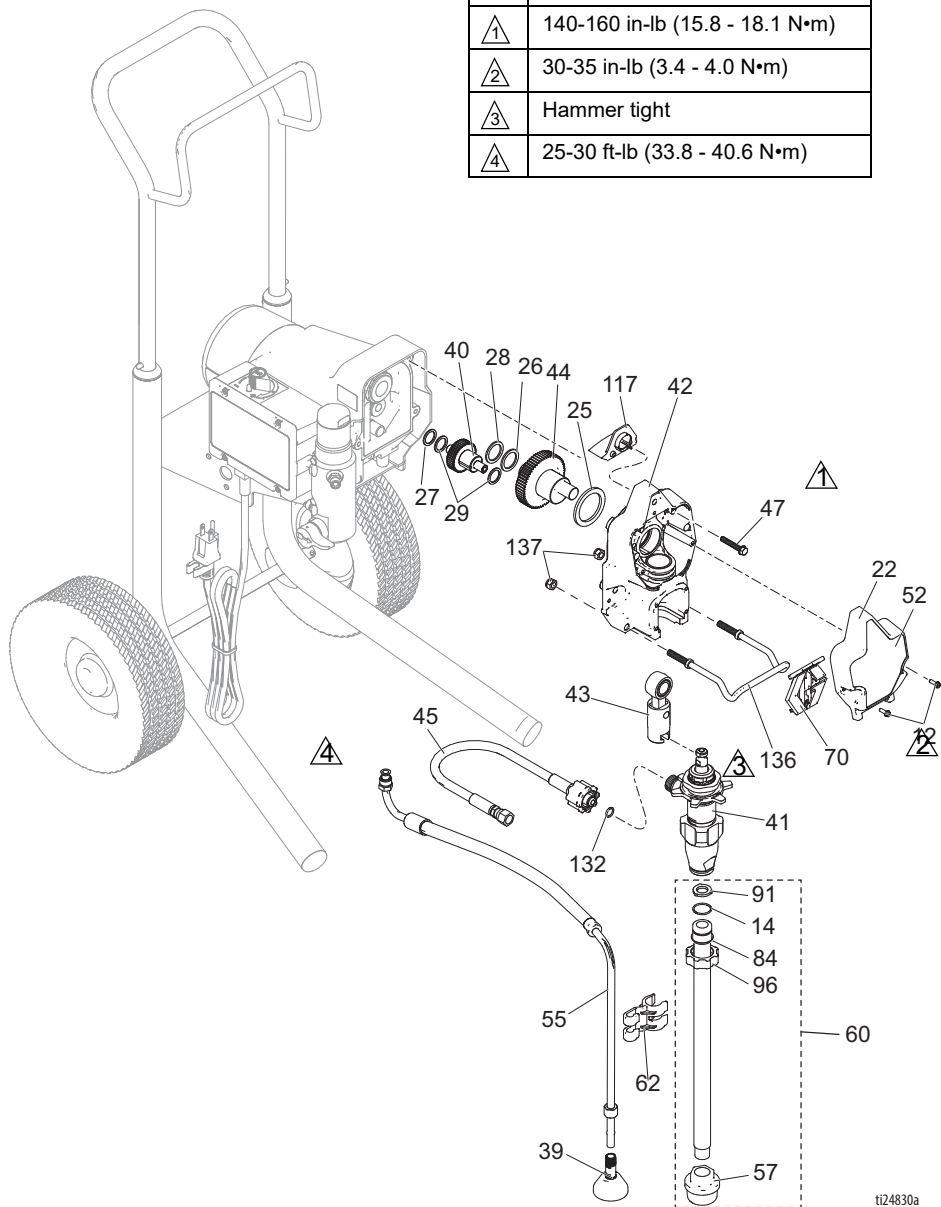

ti24830a



## Hi-Boy Sprayers Parts List

| Ref. | Part        | Description                               | Qty. | Ref.   | Part                          | Description   | Qty. |
|------|-------------|---|------|--------|-------------------------------|---|------|
| 12   | 117501      | SCREW, mach, hex washer hd                | 4    | 54b    | 248189                        | FAN, motor, <i>includes 54a</i>                       | 1    |
| 14   | 103413      | O-ring                                    | 1    | 55     | 287952                        | HOSE, drain, <i>includes 39</i>                       | 1    |
| 22   | 17C539      | COVER, front, painted                     | 1    | 57     | 246385                        | STRAINER, 7/8-14 unf                                  | 1    |
| 23   | 15B465      | SHIELD, motor, painted                    | 1    | 59     | 17C485                        | FRAME, cart, hi                                       | 1    |
| 25   | 180131      | BEARING, thrust                           | 1    | 60     | 17C992                        | KIT, stinger tube, <i>includes 14, 57, 84, 91, 96</i> | 1    |
| 26   | 107434      | BEARING, thrust                           | 1    | 61     | See page 50                   | GUN, spray  | 1    |
| 27   | 116073      | WASHER, thrust                            | 1    | 62     | 276888                        | CLIP, drain line                                      | 1    |
| 28   | 116074      | WASHER, thrust                            | 1    | 63▲    | See page 50                   | LABEL, danger   | 1    |
| 29   | 116079      | BEARING, thrust                           | 2    | 65▲    | See page 50                   | LABEL, warning  | 1    |
| 33   | 206994      | FLUID, TSL (not shown)                    | 1    | 67     | 109032                        | SCREW, pan hd   | 4    |
| 34▲  | See page 50 | CARD, medical alert (not shown)           | 1    | 69     | 287489                        | HANDLE  | 1    |
| 39   | 241920      | DEFLECTOR, threaded                       | 1    | 70     | 17C483                        | COVER, pump rod                                       | 1    |
| 40   | 249194      | GEAR, reducer                             | 1    | 75     | 108691                        | PLUG, tubing  | 2    |
| 41   | 17C487      | PUMP, displacement, PC, North America     | 1    | 84     | 15B652                        | WASHER, suction                                       | 1    |
| 42   | 24W817      | HOUSING, drive, PC, <i>includes 47</i>    | 1    | 91     | 115099                        | WASHER, hose  | 1    |
| 43   | 24W640      | ROD, connecting, PC                       | 1    | 96     | 15E813                        | NUT, jam  | 1    |
| 44   | 24X020      | GEAR, crankshaft, <i>includes 25</i>      | 1    | 117    | 15G447                        | PLUG, shield, painted                                 | 1    |
| 45   | 24W830      | KIT, hose, cpld, PC, <i>includes 132</i>  | 1    | 132    | 16H137                        | PACKING, O-ring                                       | 1    |
| 46   | See page 50 | HOSE, cpld, 1/4 in. x 50 ft               | 1    | 133    | 106062                        | WHEEL   | 2    |
| 47   | 117493      | SCREW, mach, hex washer hd                | 8    | 134    | 15B999                        | CLIP, retaining                                       | 2    |
| 52   | See page 50 | LABEL, front                              | 1    | 135    | 104811                        | CAP, hub  | 2    |
| 53   | See page 50 | LABEL, side                               | 1    | 136    | 17C990                        | HANGER, pail  | 1    |
| 54*  | 287015      | MOTOR, <i>includes 54a, 54b, 100-120V</i> | 1    | 137    | 111040                        | NUT, lock, insert, nylon                              | 2    |
| 54a  | 118716      | RING, retaining                           | 1    | 206994 | FLUID, TSL, 8 oz. (not shown) | 1   |      |

\* For motor brush kit order 287735





▲ Replacement safety labels, tags, and cards are available at no cost.

# Accessories and Labels

## Accessories and Labels

| Sprayer Model  | Ref. 34 Card, Medical Alert ▲ | Ref. 46 Hose, 1/4 in. x 50 ft | Ref. 52 Label, Front | Ref. 53 Label, Side | Ref. 61 Gun, Spray | Ref. 63 Label, Danger ▲ | Ref. 65 Label, Warning ▲ |
|--|-------------------------------|-------------------------------|----------------------|---------------------|--------------------|-------------------------|--------------------------|
| 17E844<br>17E845<br>17E846   | 222385 #                      | 240794                        | 17E940               | 17E941              | 17Y042             | 15B516 &                | 195793 &                 |
| 17E879   | 17A134 %                      | 240794                        | 17E940               | 17E941              | 17Y044             | 15H087 @                | 195792 @                 |
| 17E880   | 17A134 %                      | 240794                        | 17E940               | 17E941              | 17Y044             | 15H086 *                | 195792 @                 |
| 17E881   | 17A134 %                      | 240794                        | 17H890               | 17H891              | 17Y044             | 15H087 @                | 195792 @                 |
| 826237<br>826238<br>826239   | 222385 #                      | 826079                        | 17E942               | 17E943              | 826252             | 15B516 &                | 195793 &                 |
| 288526 – Kit, accessory, hopper  |                               |                               |                      |                     |                    |                         |                          |
| # – English, Spanish, French   |                               |                               |                      |                     |                    |                         |                          |
| % – English, Chinese, Korean   |                               |                               |                      |                     |                    |                         |                          |
| & – North America  |                               |                               |                      |                     |                    |                         |                          |
| @ – Asia/ANZ   |                               |                               |                      |                     |                    |                         |                          |
| * – Japan  |                               |                               |                      |                     |                    |                         |                          |
| ▲ Replacement safety labels, tags, and cards are available at no cost. |                               |                               |                      |                     |                    |                         |                          |

## Control Box

| Ref.  | Torque                          |
|---|---------------------------------|
|  | 140-160 in-lb (15.8 - 18.1 N•m) |
|  | 30-35 in-lb (3.4 - 4.0 N•m)     |
|  | 20-25 in-lb (2.3 - 2.8 N•m)     |
|  | 37-43 ft-lb (50.2 - 58.3 N•m)   |
|  | 130-150 in-lb (14.7 - 16.9 N•m) |

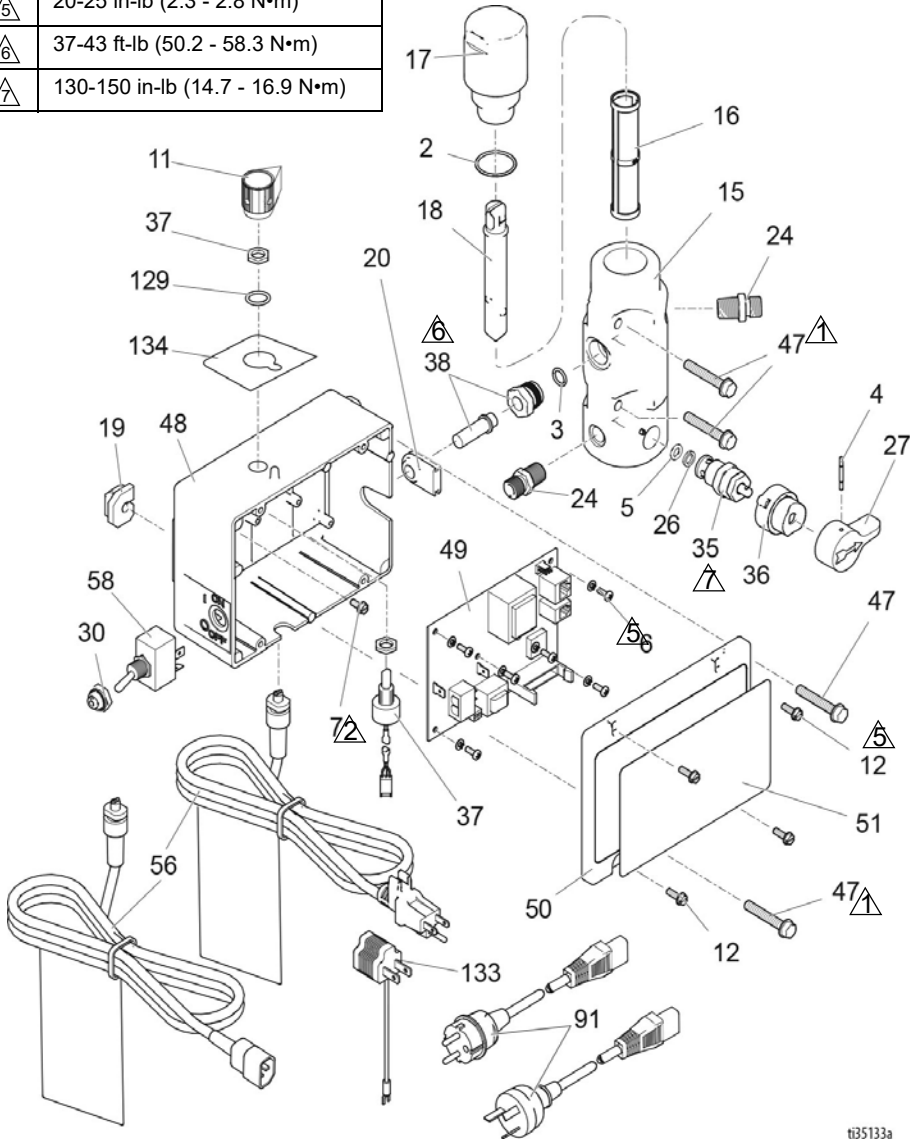

t35133a

# Control Box

## Control Box Parts List

| Ref. Part | Description | Qty.                                | Ref. Part | Description | Qty.   |   |   |
|-----------|-------------|-------------------------------------|-----------|-------------|--------|---|---|
| 2         | 117828      | PACKING, o-ring                     | 1         | 37          | 17D888 | POTENTIOMETER, assembly                         | 1 |
| 3         | 111457      | PACKING, o-ring                     | 1         | 38          | 243222 | TRANSDUCER, pressure control, <i>includes 3</i> | 1 |
| 4         | 111600      | PIN, grooved                        | 1         | 47          | 117493 | SCREW, mach, hex washer hd                      | 4 |
| 5         | 277364      | GASKET, seat, valve                 | 1         | 48          | 276868 | BOX, control                                    | 1 |
| 6         | 115494      | SCREW, mach, Phillips, pan hd       | 6         | 49          |        | CONTROL, board                                  | 1 |
| 7         | 115498      | SCREW, mch, slot/hex, wash hd       | 1         |             | 246379 | 120V, US/Japan                                  |   |
| 11        | 116167      | KNOB, potentiometer                 | 1         |             | 246380 | 230V, Asia/ANZ                                  |   |
| 12        | 117501      | SCREW, mach, hex washer hd          | 4         | 50          |        | COVER   | 1 |
| 15        |             | MANIFOLD, fluid                     | 1         |             | 276882 | COVER, control, without display                 |   |
|           | 15G455      | Models without pressure gauge       |           |             | 287098 | COVER, digital, display <i>includes 51</i>      |   |
|           | 15T811      | Models with pressure gauge          |           | 51          |        | LABEL, control                                  | 1 |
| 16        |             | FILTER, fluid                       | 1         |             | 15K393 | ULTRA   |   |
|           | 246425      | 30 mesh                             |           |             | 15B373 | Ultimate NOVA                                   |   |
|           | 246384      | 60 mesh, original                   |           |             | 15K400 | Models with display                             |   |
|           | 246382      | 100 mesh                            |           | 56          |        | CORD, power                                     | 1 |
|           | 246383      | 200 mesh                            |           |             | 15J743 | US/Japan  |   |
| 17        | 287902      | CAP, manifold, <i>includes 18</i>   | 1         |             | 253373 | Multicord, Asia/ANZ                             |   |
| 18        | 15B071      | INSERT, filter                      | 1         | 58          |        | SWITCH, toggle                                  | 1 |
| 19        | 15B118      | BUSHING, motor wire                 | 1         |             | 195429 | 120V, US/Japan                                  |   |
| 20        | 15B120      | GROMMET, transducer                 | 1         |             | 117492 | 230V Asia/ANZ                                   |   |
| 24        | 162453      | NIPPLE, (1/4 npsm x 1/4 npt)        | 2         | 91          |        | CORD SET, adapter                               | 1 |
| 26        | 15E022      | SEAT, valve                         | 1         |             | 242001 | Europe  |   |
| 27        | 187625      | HANDLE, valve, drain                | 1         |             | 242005 | Australia                                       |   |
| 30        | 195428      | BOOT, toggle                        | 1         | 129         | 158674 | O-ring, packing                                 | 1 |
| 35        | 239914      | VALVE, drain, <i>includes 5, 26</i> | 1         | 133         | 244285 | ADAPTER, Japan                                  | 1 |
| 36        | 224807      | BASE, valve                         | 1         | 134         | 17P737 | LABEL, pressure, adjustment                     |   |

## Wiring Diagrams

100/120V

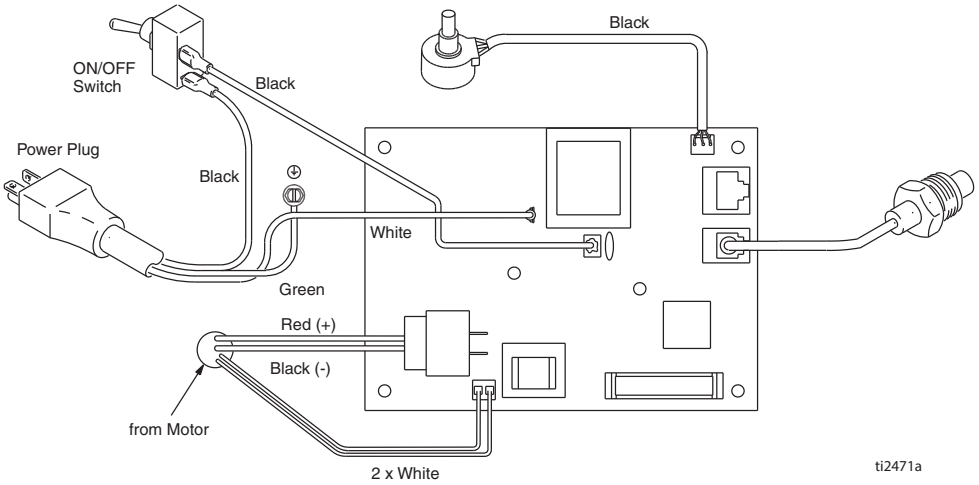

# Wiring Diagrams

## 230V

### NOTICE

Heat from inductor coil of filter board may destroy wire insulation that comes in contact with it. Exposed wires could cause shorts and component damage. Bundle and tie loose wires so none lay in contact with inductor coil on the filter board.

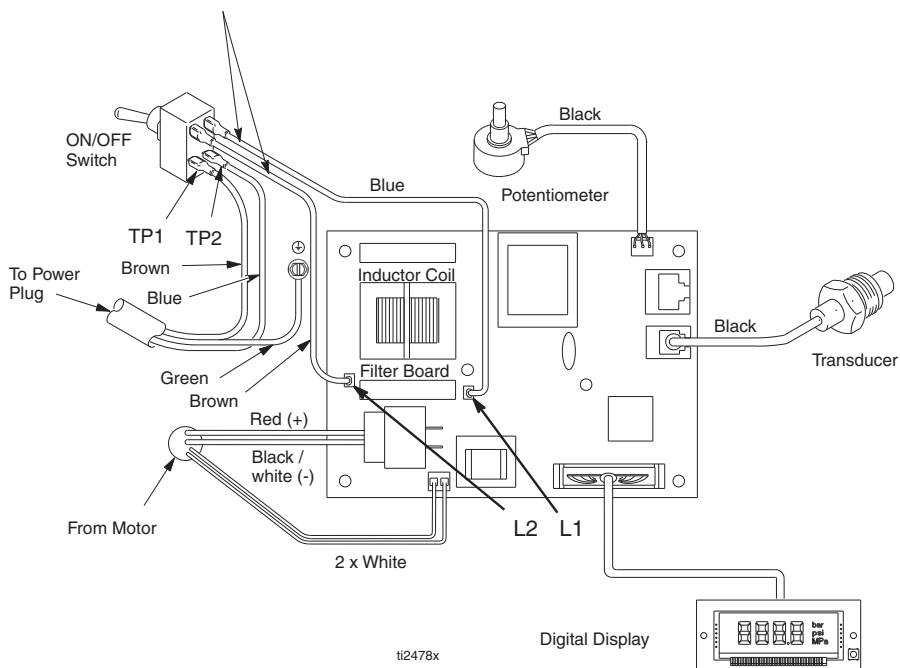

## Technical Specifications

| Ultra 395 PC, Ultimate NOVA 395 PC, Ultra 395 PC Pro |  |  |
|--|--|--|
| Sprayer  |  |  |
|  | US   | Metric                                       |
| Maximum fluid working pressure                       | 3300 psi   | 228 bar, 22.8 MPa                            |
| Maximum Delivery                                     | 0.54 gpm   | 2.0 lpm                                      |
| Maximum Tip Size                                     | 0.023  | 0.023  |
| Fluid Outlet npsm                                    | 1/4 in.  | 1/4 in.                                      |
| Cycles   | 700 per gallon   | 185 per liter                                |
| Generator Minimum                                    | 3000 W   | 3000 W                                       |
| 110–120V, A, Hz                                      | 1Ø, 15, 50/60  |  |
| 220–240V, A, Hz                                      | 1Ø, 7, 50/60   |  |
| Dimensions   |  |  |
|  | US   | Metric                                       |
| Height   |  |  |
| Stand  | 18.5 in.   | 47 cm  |
| Lo-Boy   | 22.5 in.   | 57.2 cm                                      |
| Hi-Boy   | 28.25 in. (Handle down)<br>38.25 in. (Handle up)   | 71.8 cm (Handle down)<br>97.2 cm (Handle up) |
| Length   |  |  |
| Stand  | 16 in.   | 40.6 cm                                      |
| Lo-Boy   | 26.5 in.   | 67.3 cm                                      |
| Hi-Boy   | 23.25 in.  | 59.1 cm                                      |
| Width  |  |  |
| Stand  | 14 in.   | 35.6 cm                                      |
| Lo-Boy   | 20 in.   | 50.6 cm                                      |
| Hi-Boy   | 20.5 in.   | 52.1 cm                                      |
| Weight   |  |  |
| Stand  | 43 lb.   | 20 kg  |
| Lo-Boy   | 63 lb.   | 29 kg  |
| Hi-Boy   | 66 lb.   | 30 kg  |
| Noise** (dBa) @ 70 psi (0.48 MPa, 4.8 bar)           |  |  |
| Sound pressure                                       | 90 dBa   |  |
| Sound power  | 100 dBa  |  |
| Materials of Construction                            |  |  |
| Wetted materials on all models                       | zinc- and nickel-plated carbon steel, nylon, stainless steel, PTFE, Acetal, leather, UHMWPE, aluminum, tungsten carbide, polyethylene, fluoroelastomer, urethane |  |

# Technical Specifications

## Ultra 395 PC, Ultimate NOVA 395 PC, Ultra 395 PC Pro

### Notes

\* *Startup pressures and displacement per cycle may vary based on suction condition, discharge head, air pressure, and fluid type.*

\*\* *Sound pressure measured 3 feet (1 meter) from equipment.  
Sound power measured per ISO-3744.*

All trademarks or registered trademarks are the property of their respective owners.

## CALIFORNIA PROPOSITION 65



**WARNING:** This product can expose you to chemicals known to the State of California to cause cancer and birth defects or other reproductive harm. For more information go to [www.P65Warnings.ca.gov](http://www.P65Warnings.ca.gov).







## Graco Standard Warranty

Graco warrants all equipment referenced in this document which is manufactured by Graco and bearing its name to be free from defects in material and workmanship on the date of sale to the original purchaser for use. With the exception of any special, extended, or limited warranty published by Graco, Graco will, for a period of twelve months from the date of sale, repair or replace any part of the equipment determined by Graco to be defective. This warranty applies only when the equipment is installed, operated and maintained in accordance with Graco's written recommendations.

This warranty does not cover, and Graco shall not be liable for general wear and tear, or any malfunction, damage or wear caused by faulty installation, misapplication, abrasion, corrosion, inadequate or improper maintenance, negligence, accident, tampering, or substitution of non-Graco component parts. Nor shall Graco be liable for malfunction, damage or wear caused by the incompatibility of Graco equipment with structures, accessories, equipment or materials not supplied by Graco, or the improper design, manufacture, installation, operation or maintenance of structures, accessories, equipment or materials not supplied by Graco.

This warranty is conditioned upon the prepaid return of the equipment claimed to be defective to an authorized Graco distributor for verification of the claimed defect. If the claimed defect is verified, Graco will repair or replace free of charge any defective parts. The equipment will be returned to the original purchaser transportation prepaid. If inspection of the equipment does not disclose any defect in material or workmanship, repairs will be made at a reasonable charge, which charges may include the costs of parts, labor, and transportation.

**THIS WARRANTY IS EXCLUSIVE, AND IS IN LIEU OF ANY OTHER WARRANTIES, EXPRESS OR IMPLIED, INCLUDING BUT NOT LIMITED TO WARRANTY OF MERCHANTABILITY OR WARRANTY OF FITNESS FOR A PARTICULAR PURPOSE.**

Graco's sole obligation and buyer's sole remedy for any breach of warranty shall be as set forth above. The buyer agrees that no other remedy (including, but not limited to, incidental or consequential damages for lost profits, lost sales, injury to person or property, or any other incidental or consequential loss) shall be available. Any action for breach of warranty must be brought within two (2) years of the date of sale.

**GRACO MAKES NO WARRANTY, AND DISCLAIMS ALL IMPLIED WARRANTIES OF MERCHANTABILITY AND FITNESS FOR A PARTICULAR PURPOSE, IN CONNECTION WITH ACCESSORIES, EQUIPMENT, MATERIALS OR COMPONENTS SOLD BUT NOT MANUFACTURED BY GRACO.** These items sold, but not manufactured by Graco (such as electric motors, switches, hose, etc.), are subject to the warranty, if any, of their manufacturer. Graco will provide purchaser with reasonable assistance in making any claim for breach of these warranties.

In no event will Graco be liable for indirect, incidental, special or consequential damages resulting from Graco supplying equipment hereunder, or the furnishing, performance, or use of any products or other goods sold hereto, whether due to a breach of contract, breach of warranty, the negligence of Graco, or otherwise.

### **FOR GRACO CANADA CUSTOMERS**

The Parties acknowledge that they have required that the present document, as well as all documents, notices and legal proceedings entered into, given or instituted pursuant hereto or relating directly or indirectly hereto, be drawn up in English. Les parties reconnaissent avoir convenu que la rédaction du présente document sera en Anglais, ainsi que tous documents, avis et procédures judiciaires exécutés, donnés ou intentés, à la suite de ou en rapport, directement ou indirectement, avec les procédures concernées.

# Graco Information

For the latest information about Graco products, visit [www.graco.com](http://www.graco.com).

For patent information, see [www.graco.com/patents](http://www.graco.com/patents).

**TO PLACE AN ORDER**, contact your Graco distributor or call 1-800-690-2894 to identify the nearest distributor.

*All written and visual data contained in this document reflects the latest product information available at the time of publication.*

*Graco reserves the right to make changes at any time without notice.*

Original instructions. This manual contains English. MM 3A6519

**Graco Headquarters:** Minneapolis  
**International Offices:** Belgium, China, Japan, Korea

**GRACO INC. AND SUBSIDIARIES • P.O. BOX 1441 • MINNEAPOLIS MN 55440-1441 • USA**

**Copyright 2018, Graco Inc. All Graco manufacturing locations are registered to ISO 9001.**

[www.graco.com](http://www.graco.com)  
Revision B, March 2019