

115 VAC EGP Oil Transfer Pump

3A8568A

EN

For pumping non-flammable fluids, including motor oils, hydraulic fluid, and antifreeze. Do not use to pump water. For professional use only.

Not approved for use in explosive atmospheres or hazardous (classified) locations.

25T820 Electric Gear Pump

3.9 gpm (14.8 lpm)

65 psi (0.45 MPa, 4.5 bar) Maximum Working Pressure

25T822 Electric Gear Pump

7.7 gpm (29.1 lpm)

65 psi (0.45 MPa, 4.5 bar) Maximum Working Pressure



Important Safety Instructions

Read all warnings and instructions in this manual before using the equipment. Save these instructions.









Contents







Warnings	3
Typical Installation	5
Installation	6
Grounding	6
Pump	6
Mount Pump on Drum	6
Mount Hose and Nozzle	6
Electrical Installation	6
Operation	7
Pressure Relief Procedure	7
Duty Cycle	7
Thermal Overload	7
Pump Start Up	7
Recycling and Disposal	8
End of Product Life	8
Troubleshooting	9
Parts	12
Kits and Accessories	14
Pump Performance Chart	16
Dimensions	17
Technical Specifications	18
California Proposition 65	19
Graco Standard Warranty	20

Warnings

The following warnings are for the setup, use, grounding, maintenance, and repair of this equipment. The exclamation point symbol alerts you to a general warning and the hazard symbols refer to procedure-specific risks. When these symbols appear in the body of this manual or on warning labels, refer back to these Warnings. Product-specific hazard symbols and warnings not covered in this section may appear throughout the body of this manual where applicable.

 <h1 style="margin: 0;">WARNING</h1>	
 	<p>FIRE AND EXPLOSION HAZARD</p> <p>When flammable fluids are present in the work area, such as gasoline and windshield wiper fluid, be aware that flammable fumes can ignite or explode. To help prevent fire and explosion:</p> <ul style="list-style-type: none"> • Use equipment only in well-ventilated area. • Eliminate all ignition sources, such as cigarettes and portable electric lamps. • Ground all equipment in the work area. • Keep work area free of debris, including rags and spilled or open containers of solvent and gasoline. • Do not plug or unplug power cords or turn lights on or off when flammable fumes are present. • Use only grounded hoses. • Stop operation immediately if static sparking occurs or you feel a shock. Do not use equipment until you identify and correct the problem. • Keep a working fire extinguisher in the work area.
 	<p>ELECTRIC SHOCK HAZARD</p> <p>This equipment must be grounded. Improper grounding, setup, or usage of the system can cause electric shock.</p> <ul style="list-style-type: none"> • Turn off and disconnect power cord before servicing equipment. • Connect only to grounded electrical outlets. • Use only 3-wire extension cords. • Ensure ground prongs are intact on power and extension cords. • Do not expose to rain. Store indoors.
	<p>BURN HAZARD</p> <p>Equipment surfaces and fluid that is heated can become very hot during operation. To avoid severe burns:</p> <ul style="list-style-type: none"> • Do not touch hot fluid or equipment.

WARNING

 	<p>EQUIPMENT MISUSE HAZARD Misuse can cause death or serious injury.</p> <ul style="list-style-type: none"> • Do not operate the unit when fatigued or under the influence of drugs or alcohol. • Do not exceed the maximum working pressure or temperature rating of the lowest rated system component. See Technical Specifications in all equipment manuals. • Use fluids and solvents that are compatible with equipment wetted parts. See Technical Specifications in all equipment manuals. Read fluid and solvent manufacturer’s warnings. For complete information about your material, request Safety Data Sheets (SDSs) from distributor or retailer. • Turn off all equipment and follow the Pressure Relief Procedure when equipment is not in use. • Check equipment daily. Repair or replace worn or damaged parts immediately with genuine manufacturer’s replacement parts only. • Do not alter or modify equipment. Alterations or modifications may void agency approvals and create safety hazards. • Make sure all equipment is rated and approved for the environment in which you are using it. • Use equipment only for its intended purpose. Call your distributor for information. • Route hoses and cables away from traffic areas, sharp edges, moving parts, and hot surfaces. • Do not kink or over bend hoses or use hoses to pull equipment. • Keep children and animals away from work area. • Comply with all applicable safety regulations.
  	<p>PRESSURIZED EQUIPMENT HAZARD Fluid from the equipment, leaks, or ruptured components can splash in the eyes or on skin and cause serious injury.</p> <ul style="list-style-type: none"> • Follow the Pressure Relief Procedure when you stop spraying/dispensing and before cleaning, checking, or servicing equipment. • Tighten all fluid connections before operating the equipment. • Check hoses, tubes, and couplings daily. Replace worn or damaged parts immediately.
	<p>PERSONAL PROTECTIVE EQUIPMENT Wear appropriate protective equipment when in the work area to help prevent serious injury, including eye injury, hearing loss, inhalation of toxic fumes, and burns. Protective equipment includes but is not limited to:</p> <ul style="list-style-type: none"> • Protective eyewear, and hearing protection. • Respirators, protective clothing, and gloves as recommended by the fluid and solvent manufacturer.

Typical Installation

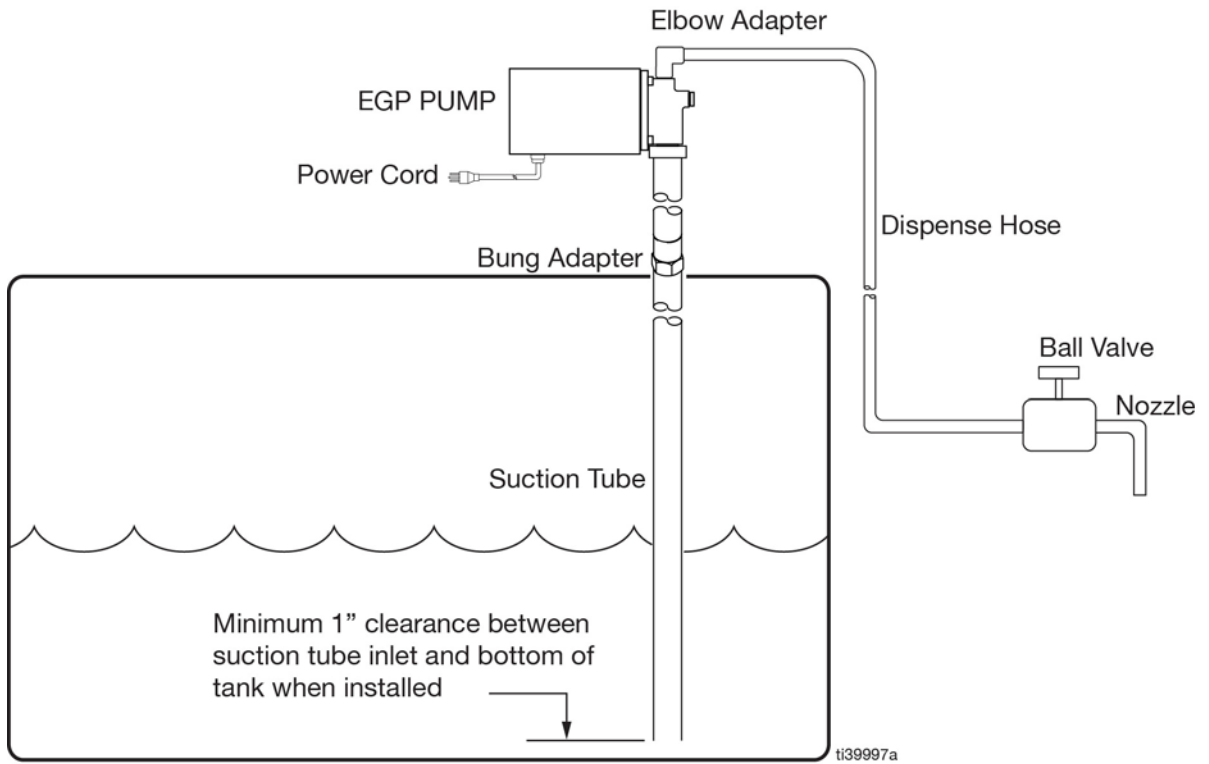







FIG. 1: Typical Installation

Installation

Grounding

				
<p>The equipment must be grounded to reduce the risk of static sparking and electric shock. Electric or static sparking can cause fumes to ignite or explode. Improper grounding can cause electric shock. Grounding provides an escape wire for the electric current.</p>				

				
<p>All electrical wiring must be done by a qualified electrician and comply with all local codes and regulations.</p>				

Pump

NOTE: The reference numbers in the following instructions refer to **Parts**, page 12.

NOTE: Pipe/thread sealant is user supplied, do not use the PVC cement supplied with the product.

The oil transfer pumps are positive displacement pumps. The motors are drip proof rated and have sealed bearings and require minimal maintenance. All models come with hose, nozzle, 34 in. (864 mm) suction tube assemble, and bung adapter.

Mount Pump on Drum

1. Install the bung adapter (14) in the drum bung and tighten.
2. Assemble the suction tube sections (18) by applying PVC cement (21) to the inside diameter of the PVC couplers (19, 20). Make sure that the PVC cement (21) is applied to the complete inside diameter and slide the pipe sections into the coupler with a twisting motion.

3. Apply pipe sealant to the threaded end of the suction tube, then screw the tube into the pump inlet port, making sure that the tube is tight.
4. Insert the suction tube attached to the pump through the bung adapter, and lower the pump onto the bung adapter. Position the pump, as desired, then tighten the swivel nut (23) to the bung adapter (14).

Mount Hose and Nozzle

1. Before connecting the hose to the pump, pour 8 oz. (0.24 l) of oil into the pump outlet port so that the pump does not run dry during the initial startup.
2. Apply pipe sealant to the male threads of the elbow (12), then secure the elbow into the outlet port.
3. Apply pipe sealant to one end of the hose assembly (17), then twist the hose end into the elbow.
4. Apply pipe sealant to the other end of the hose assembly (17).
5. Apply thread sealant onto the nozzle (15) end that connects to the ball valve (16).
6. Fasten the ball valve and nozzle (15, 16) onto the hose assembly, positioning the nozzle (15) down for dispensing.

Electrical Installation

115 VAC

The 115 VAC models come wired with a short power cord and a grounding electrical plug. Power to the unit must be grounded 115 VAC single phase. If an extension cord is required, it must be a 3-wire cord with a grounding plug and a grounding receptacle. Supply power to the pump using a 20 amp circuit.

Operation

Pressure Relief Procedure

 Follow the Pressure Relief Procedure whenever you see this symbol.



This equipment stays pressurized until pressure is manually relieved. To help prevent serious injury from pressurized fluid, such as splashing fluid and moving parts, follow the Pressure Relief Procedure when you stop dispensing and before cleaning, checking, or servicing the equipment.

1. Turn off and disconnect the power supply.
2. Trigger the dispense valve into a grounded waste container to relieve pressure.

Duty Cycle

The pump is designed to operate at a 50% duty cycle. It can operate up to a maximum of 30 minutes of run time, with an equal amount of down time.

NOTICE

Never allow the pump to operate dry. Make sure that the pump has fluid in it when the pump is initially installed. Do not run the pump for more than five (5) minutes with the pump discharge blocked. Do not operate the pump continuously more than 30 minutes in one (1) hour. Failure to follow these instructions can result in damage to the pump.

Thermal Overload

The motor has a thermal overload switch that shuts the motor down when overheated. If the unit overheats, allow approximately 45 minutes for the unit to cool. Once the unit has cooled down, the switch will close and the unit will restart.

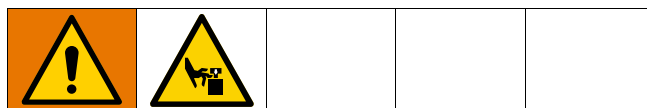

To reduce risk of injury from motor starting unexpectedly when it cools, always turn the power switch to OFF if the motor shuts down.

Pump Start Up

1. Check that the ball valve is in the OFF position.
2. Turn the power switch, located on the back of the motor, to the ON position to start the pump.

NOTE: The pump has an internal bypass valve (Pressure Relief Valve) that opens when the pump discharge pressure exceeds 65 psi. If the flow is blocked, the fluid will bypass within the pump.

3. Insert the nozzle (15) into the container and open the ball valve (16) to dispense fluid.
4. Turn the switch to the OFF position immediately after finishing dispensing.
5. Close the ball valve (16).

Recycling and Disposal

End of Product Life

At the end of the product's useful life, dismantle and recycle it in a responsible manner.

- Perform the **Pressure Relief Procedure**.
- Drain and dispose of fluids according to applicable regulations. Refer to the material manufacturer's Safety Data Sheet.
- Remove motor and power cord components. Recycle according to applicable regulations.
- Deliver remaining product to a recycling facility.

Troubleshooting



1. Follow **Operation**, page 7, before checking or repairing the equipment.
2. Check all possible problems and causes before disassembling the equipment.

Problem	Cause	Solution
Motor is running, but the pump will not prime.	There is dirt under the pressure relief valve.	Remove the pressure relief valve and inspect. Clean or replace the pump housing assembly.
	The gears are worn or damaged.	Remove the cover and inspect the gears. If damaged, replace the pump housing assembly.
	The oil level is low.	Refill or replace the drum.
	There is an air leak in the suction tube.	Inspect all joints in the suction tube making sure that all threaded joints have sealant applied properly. Fill pump outlet port with oil.
	There is an air lock in the system.	Fill the system with fluid by keeping nozzle open by operating the pump.
	The motor does not run at the proper speed.	Check the electric connections. Ensure the supply voltage is at the proper level.
Oil is leaking in the motor mount.	A faulty or damaged motor shaft seal.	Replace the pump housing assembly.
	The nozzle was closed for an extended period of time during pump operation.	Do not exceed five (5) minutes of operation with the nozzle closed.
	A worn motor shaft.	Replace with a new pump.

Problem	Cause	Solution
The unit pumps, but the output flow is low.	The inlet suction screen is clogged (used oil).	Remove the inlet suction screen using a 3/4 in. (19 mm) hex wrench. Clean or replace the inlet suction screen.
	There is an air leak in the suction tube.	Inspect all joints in the suction tube making sure that they are sealed.
	The suction tube is too close to the drum bottom.	The suction tube must have a 1 in. (25.4 mm) minimum clearance.
	The drum is empty.	Refill or replace the drum.
	The drum is not vented.	Vent the drum to atmosphere.
	The gears are worn or damaged.	Remove the cover and inspect the gears. If damaged, replace the pump housing assembly.
	The motor does not run at the proper speed.	Check the electrical connection and verify the supply voltage.
	The suction tube, hose, or nozzle is clogged.	Inspect and clean the suction tube, hose, or nozzle, and replace as needed.
The motor stalls when the nozzle is closed.	The bypass relief valve is stuck.	Remove and inspect the pressure relief valve. Clean, or replace if it is damaged.
	The supply voltage is low.	Check the supply voltage.
	The gears are damaged and binding.	Inspect the gears. If they do not turn freely, or are damaged, replace the pump housing assembly.
	The motor is faulty.	Replace with a new pump.
The motor overheats.	The gears are binding.	Inspect the gears. If they do not turn freely, or are damaged, replace the pump housing assembly.
	The nozzle was closed for an extended time during pump operation.	Do not exceed five (5) minutes of operation with the nozzle closed.
	The inlet suction screen is clogged.	Remove the inlet suction screen using a 3/4 in. (19 mm) hex wrench. Clean or replace the inlet suction screen.
	The suction tube, hose, or nozzle is clogged.	Inspect and clean the suction tube, hose, or nozzle.
	Operating the pump for more than 30 minutes of continuous duty.	Limit operation to 30 minutes per hour.

Problem	Cause	Solution
The switch does not turn the pump on.	The fuse or circuit breaker is blown.	Check the electrical supply.
	There is an electrical problem.	Check that proper supply voltage is getting to the pump.
	There is a defective switch.	Replace with a new pump.
	The motor is damaged or defective.	
	The motor thermal overload switch is activated.	Allow the unit to cool down for approximately 45 minutes. After it has cooled down, inspect the pump for any overload condition.

Parts

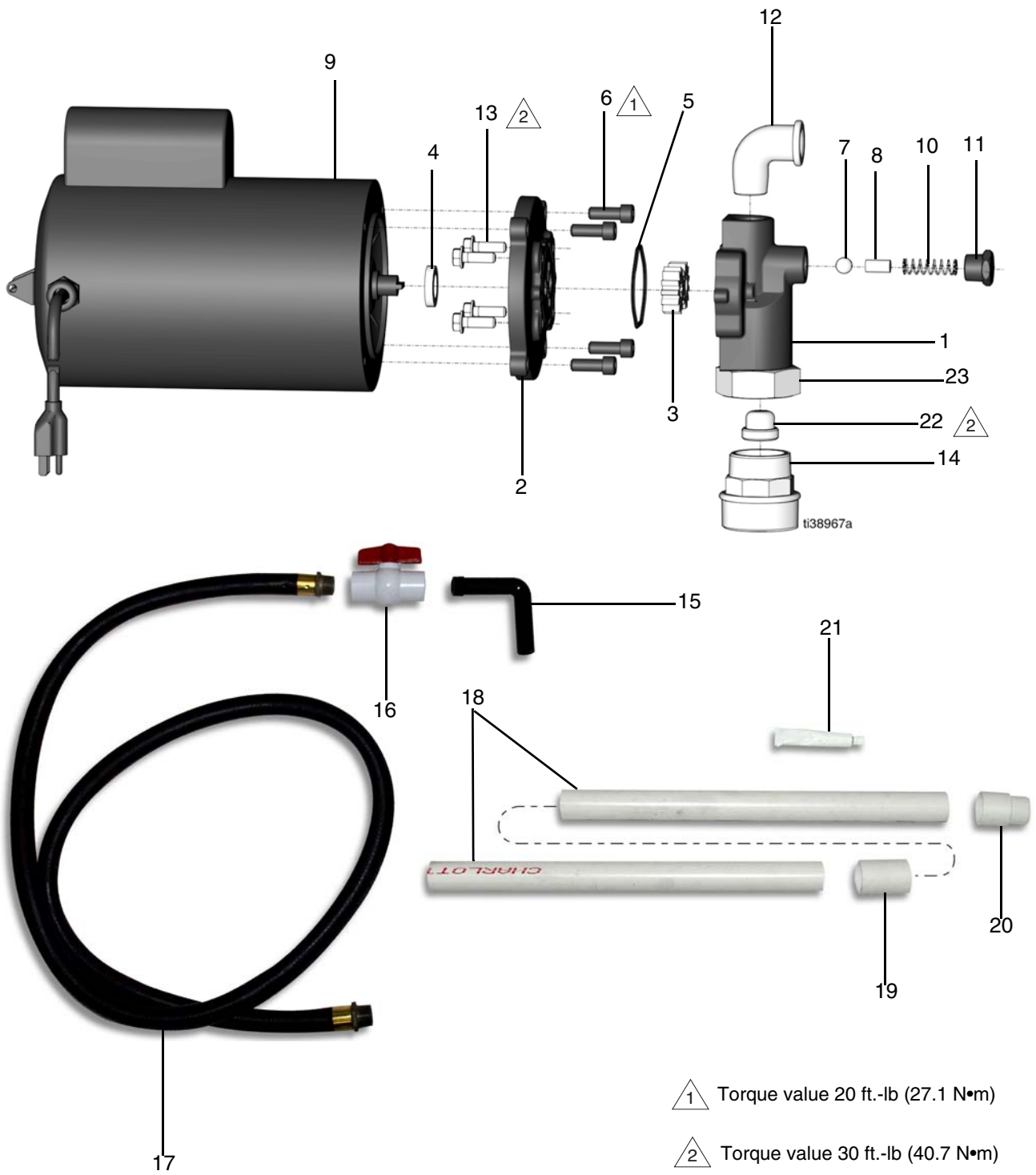





Ref.	Part No.	Description	Qty.
1❖		Pump body	1
2❖		Adapter, pump motor	1
3❖		Gear, pump	2
4❖		Seal, shaft	1
5❖		O-ring	1
6❖		Screw, 3/8 - 16 socket head, cap	4
7❖		Ball, relief valve	1
8❖		PIN, dowel, steel 3/8 x 3/4	1
9		Motor, 115 VAC	1
10❖		Spring, relief valve	1
11❖		Plug, 12 npt	1
12†		Elbow, street, 3/4 npt	1
13❖		Screw, cap, 5/16-18	4
14❖		Adapter, bung	1
15†		Nozzle	1
16†		Valve, ball	1
17†		Hose, petroleum	1
18❖		Pipe, PVC	2
19❖		Coupler, PVC, female	1
20❖		Adapter, PVC, male	1
21❖		Cement, PVC	1
22❖	133377	Inlet Suction Screen	1
23❖		Swivel Nut	1



❖ Part of 133372 Pump Housing assembly

† Part of 133376 Dispense Kit

❖ Part of 133375 Suction Kit

Kits and Accessories

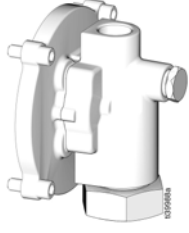
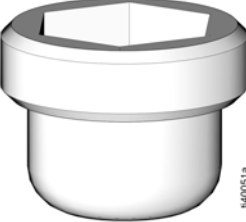
Part Number	Description	
133412	Wall mounting kit	 <p style="text-align: right; font-size: small;">t139968a</p>
260238	Y strainer	 <p style="text-align: right; font-size: small;">t139969a</p>
260124	Suction tube with inlet check assembly	 <p style="text-align: right; font-size: small;">t139970a</p>
133376	Dispense kit	 <p style="text-align: right; font-size: small;">t139972a</p>

Part Number	Description	
133372	Pump housing assembly 230/115 V Transfer Pump	
133377	Suction filter	
133375	Suction kit	

Pump Performance Chart

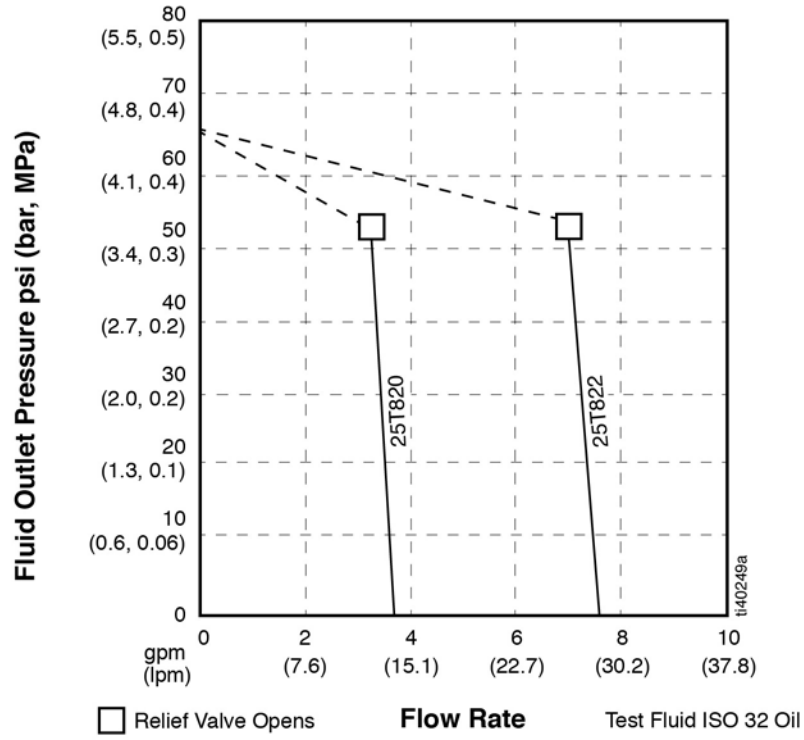

Dimensions

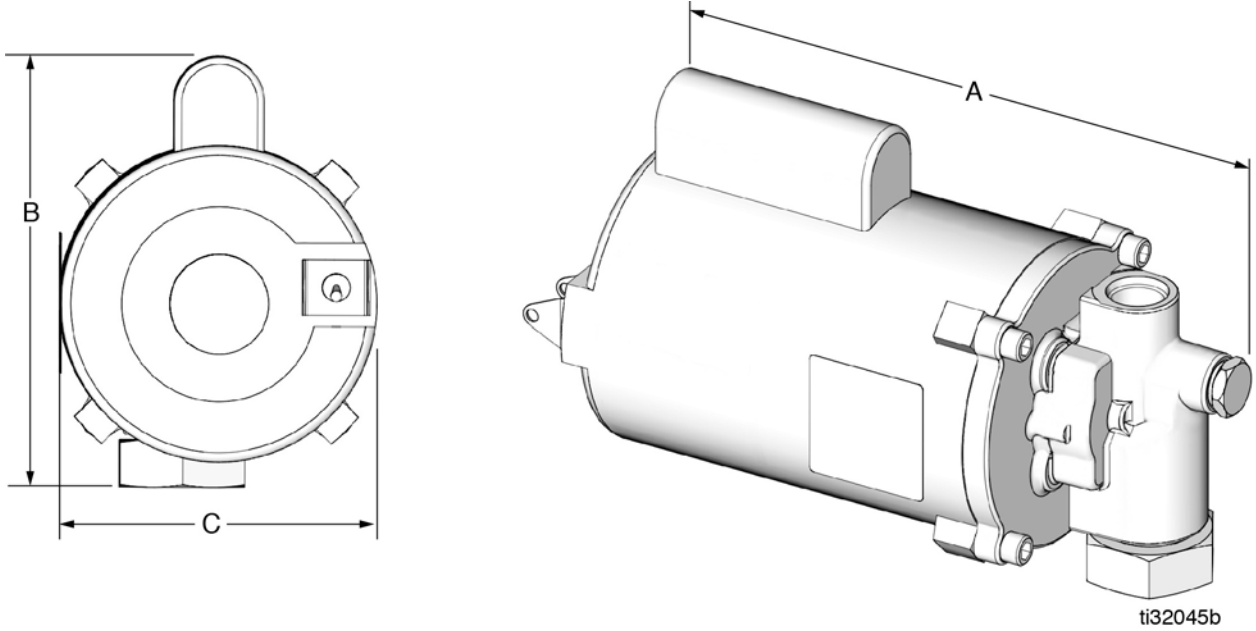

Models	Length (A)		Height (B)		Width (C)	
	Inches	mm	Inches	mm	Inches	mm
25T820	14.0	356.0	8.7	221	6.5	165.0
25T822	14.0	356.0	8.7	221	6.5	165.0

Technical Specifications

115 VAC Electric Gear Pump		
	US	Metric
Maximum working pressure	65 psi	0.45 MPa, 4.5 bar
Automatic Relief Setting	65 psi	0.45 MPa, 4.5 bar
Output Flow at 0 psi (0 MPa, 0 bar), see Pump Performance Chart , page 16		
25T820	3.9 gpm	14.8 L/min
26T822	7.7 gpm	29.1 L/min
Dimensions	See Dimensions , page 17	
Power Cord	30 in.	762 mm
Hose Size	8 ft., 3/4 in ID	2.4 m, 19 mm
Suction Tube	34 in.	864 mm
Weight		
	25T820	21.5 lb. 9.8 kg
	25T822	24.6 lb. 11.2 kg
Motor Details		
Voltage	25T820	115 VAC, 60 Hz
	25T822	
Current	25T820	8.7 A
	25T822	9.91 A
Power	25T820	0.5 HP
	25T822	0.75 HP
Enclosure	25T820	ODP
	25T822	
IP Protection	25T820	IP21
	25T822	
RPM	25T820	1700
	25T822	3500
Wetted Parts	Carbon steel with zinc plating, stainless steel, galvanized steel, aluminum, nitrile, rubber, PVC, PVC cement	
Inlet/Outlet Sizes		
Inlet size	1 in. npt(f)	
Outlet Size	3/4 in. npt(f)	

California Proposition 65

CALIFORNIA RESIDENTS

 **WARNING:** Cancer and reproductive harm – www.P65warnings.ca.gov.

Graco Standard Warranty

Graco warrants all equipment referenced in this document which is manufactured by Graco and bearing its name to be free from defects in material and workmanship on the date of sale to the original purchaser for use. With the exception of any special, extended, or limited warranty published by Graco, Graco will, for a period of twelve months from the date of sale, repair or replace any part of the equipment determined by Graco to be defective. This warranty applies only when the equipment is installed, operated and maintained in accordance with Graco's written recommendations.

This warranty does not cover, and Graco shall not be liable for general wear and tear, or any malfunction, damage or wear caused by faulty installation, misapplication, abrasion, corrosion, inadequate or improper maintenance, negligence, accident, tampering, or substitution of non-Graco component parts. Nor shall Graco be liable for malfunction, damage or wear caused by the incompatibility of Graco equipment with structures, accessories, equipment or materials not supplied by Graco, or the improper design, manufacture, installation, operation or maintenance of structures, accessories, equipment or materials not supplied by Graco.

This warranty is conditioned upon the prepaid return of the equipment claimed to be defective to an authorized Graco distributor for verification of the claimed defect. If the claimed defect is verified, Graco will repair or replace free of charge any defective parts. The equipment will be returned to the original purchaser transportation prepaid. If inspection of the equipment does not disclose any defect in material or workmanship, repairs will be made at a reasonable charge, which charges may include the costs of parts, labor, and transportation.

THIS WARRANTY IS EXCLUSIVE, AND IS IN LIEU OF ANY OTHER WARRANTIES, EXPRESS OR IMPLIED, INCLUDING BUT NOT LIMITED TO WARRANTY OF MERCHANTABILITY OR WARRANTY OF FITNESS FOR A PARTICULAR PURPOSE.

Graco's sole obligation and buyer's sole remedy for any breach of warranty shall be as set forth above. The buyer agrees that no other remedy (including, but not limited to, incidental or consequential damages for lost profits, lost sales, injury to person or property, or any other incidental or consequential loss) shall be available. Any action for breach of warranty must be brought within two (2) years of the date of sale.

GRACO MAKES NO WARRANTY, AND DISCLAIMS ALL IMPLIED WARRANTIES OF MERCHANTABILITY AND FITNESS FOR A PARTICULAR PURPOSE, IN CONNECTION WITH ACCESSORIES, EQUIPMENT, MATERIALS OR COMPONENTS SOLD BUT NOT MANUFACTURED BY GRACO. These items sold, but not manufactured by Graco (such as electric motors, switches, hose, etc.), are subject to the warranty, if any, of their manufacturer. Graco will provide purchaser with reasonable assistance in making any claim for breach of these warranties.

In no event will Graco be liable for indirect, incidental, special or consequential damages resulting from Graco supplying equipment hereunder, or the furnishing, performance, or use of any products or other goods sold hereto, whether due to a breach of contract, breach of warranty, the negligence of Graco, or otherwise.

FOR GRACO CANADA CUSTOMERS

The Parties acknowledge that they have required that the present document, as well as all documents, notices and legal proceedings entered into, given or instituted pursuant hereto or relating directly or indirectly hereto, be drawn up in English. Les parties reconnaissent avoir convenu que la rédaction du présente document sera en Anglais, ainsi que tous documents, avis et procédures judiciaires exécutés, donnés ou intentés, à la suite de ou en rapport, directement ou indirectement, avec les procédures concernées.

Graco Information

For the latest information about Graco products, visit www.graco.com.

For patent information, see www.graco.com/patents.

TO PLACE AN ORDER, contact your Graco distributor or call to identify the nearest distributor.

Phone: 612-623-6928 **or Toll Free:** 1-800-533-9655, **Fax:** 612-378-3590

*All written and visual data contained in this document reflects the latest product information available at the time of publication.
Graco reserves the right to make changes at any time without notice.*

Original instructions. This manual contains English. MM 3A8568

Graco Headquarters: Minneapolis

International Offices: Belgium, China, Japan, Korea

GRACO INC. AND SUBSIDIARIES • P.O. BOX 1441 • MINNEAPOLIS MN 55440-1441 • USA
Copyright 2021, Graco Inc. All Graco manufacturing locations are registered to ISO 9001.

www.graco.com
Revision A, June 2021