



Southwire™

TOOLS & EQUIPMENT

Operating Instructions

MAX PUNCH™ HSP HYDRAULIC STUD PUNCH



Southwire™

TOOLS & EQUIPMENT

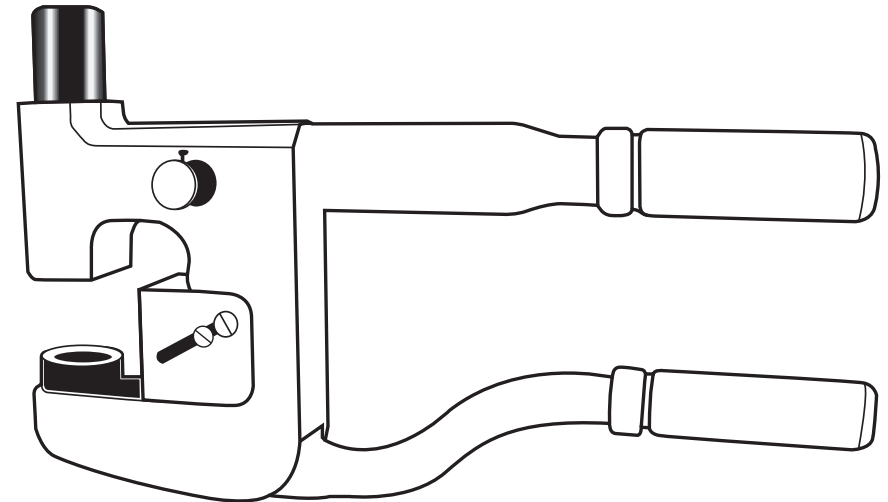

Scan for more information
and to register this product.
Para mayores informes, y para
registrar este producto, escanee
este código

Product distributed by Southwire Company, LLC
Producto distribuido por Southwire Company, LLC

Call: 855-SWT00LS (855-798-6657)
or visit www.southwiretools.com
Llame al 855-SWT00LS (855-798-6657)
o visite www.southwiretools.com

CAUTION: Please READ and UNDERSTAND all of the instructions
and safety information in this manual and observe safe-working
practices before operating or servicing this tool.



BEFORE OPERATING THIS TOOL, READ AND UNDERSTAND ALL OF THE INSTRUCTIONS AND SAFETY INFORMATION IN THIS MANUAL



TABLE OF CONTENTS

Important Safety Information.....	2
Description of Operation.....	3
Identification.....	3
Operating Instructions.....	4
Maintenance.....	5
Specifications.....	6
Warranty.....	6

SAFETY FIRST

Safety is essential in the use and maintenance of Southwire Tools & Equipment. This instruction manual and any markings on the tool provide information for avoiding hazards and unsafe practices related to the use of this tool. Observe all of the safety information provided.



SAFETY ALERT SYMBOLS

These symbols are used to call attention to hazards or unsafe practices related that could result in injury or property damage. The three safety words defined below indicate the severity of the hazard. The message after the signal word provides information for preventing or avoiding the hazard.

⚠ DANGER

Immediate hazards which, if not avoided, WILL result in severe injury or death.

⚠ WARNING

Hazards which, if not avoided, COULD result in severe injury or death.

⚠ CAUTION

Hazards or unsafe practices which, if not avoided, MAY result in injury or property damage.



⚠ WARNING

Read and understand all of the instructions and safety information in this manual before operating or servicing this tool.

Failure to observe this warning could result in severe injury or death.

⚠ WARNING

Personal safety hazards



- Only qualified persons should use a HYDRAULIC STUD PUNCH
- Wear eye protection and a hard hat when using this tool
- Do not use tool while tired or under the influence of drugs, alcohol, or medication
- Keep body parts and loose clothing away from moving parts
- Always follow safety procedures
- Keep clear of cutting die when moving handle



⚠ WARNING

Electrical Shock Hazards

- This is not an insulated tool, contact with live circuits could result in severe injury or death.

⚠ CAUTION

- Do not add extensions (cheaters) to the handles. Using excessive force may result in injury or damage to the tool. If excessive force is required to complete a knockout, verify that the type and thickness of material do not exceed the capacity of the tool
- Remnants can become projectiles through remnant opening. Make sure to wear proper eye protection and clear the area around the remnant opening.

FAILURE TO OBSERVE THESE WARNINGS CAN RESULT IN SEVERE INJURY OR DEATH

DESCRIPTION OF OPERATION

The MAX PUNCH™ HSP Hydraulic Stud Punch is intended to punch $\frac{7}{8}$ " and $1\frac{11}{32}$ " diameter round holes in the center of $3\frac{5}{8}$ " and 6" structural steel studs up to 16 gauge (.0625") thickness.

IDENTIFICATION

- (1.) Cutting Ram - Punches hole into steel stud
- (2.) Cutting Ram Cup
- (3.) Quick Guide Adjuster - Locks the Sliding Stop into desired position
- (4.) Pressure Release Knob - Retracts Cutting Ram after knock out has been made
- (5.) Actuating Handle - Actuates the Cutting Ram
- (6.) Remnant Opening - Pass through for knock out remnant

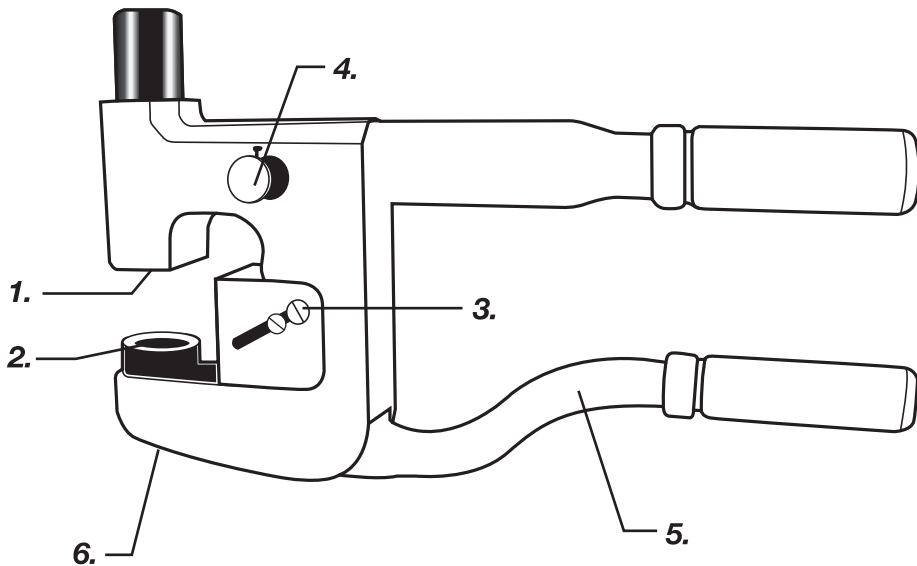

OPERATION

1. Adjust Quick Guide Adjuster (**see figures 1a and 1b**)
 - 1a. If knocking out a hole into the center of a $3\frac{5}{8}$ " steel stud. Move Quick Guide towards Cutting Ram. Sliding stop lock will automatically engage.

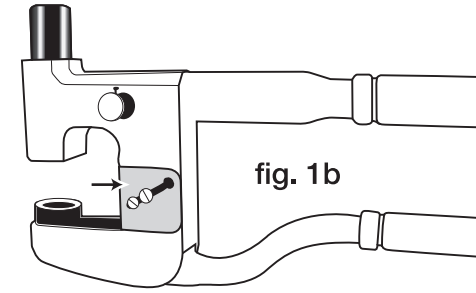
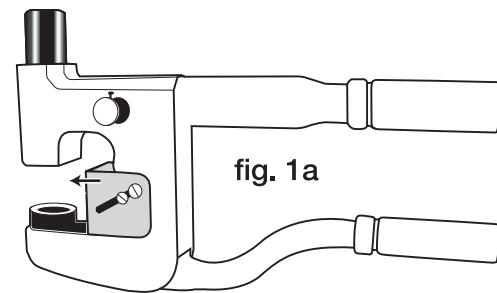

- 1b. If knocking out a hole into the center of a 6" steel stud. Press Quick Guide Adjuster Lock, sliding adjuster away from the Cutting Ram.

2. Make sure Pressure Release Knob is in the closed position by turning knob fully **clockwise**.
3. Place Quick Guide Adjuster against side of steel stud with Cutting Ram facing the deep side of the stud.
4. Pump the Actuating Handle to position the ram against the stud.
5. Make sure Cutting Ram is in line with desired cut area.
6. Pump Actuating Handle until hole is punched into the stud.
Note: Punch remnants can become a projectile, make sure to wear eye protection and clear path of Remnant Opening. If excessive force is required, stop and inspect the tool and/or material.
7. Turn Pressure Release Knob **counterclockwise** to retract Cutting Ram.

MAINTENANCE

REPLACING HYDRAULIC FLUID (see figures 1, 2, 3, and 4)

1. Unscrew the stationary handle cylinder.
2. Pinch bladder end with one hand while pulling out the plug with a pair of pliers.
3. Add oil: leave ½" to 1" space between the oil level and the end of the bladder.
4. Replace oil plug.
5. Screw back on stationary handle cylinder.

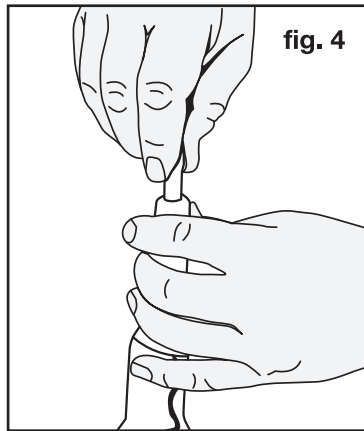
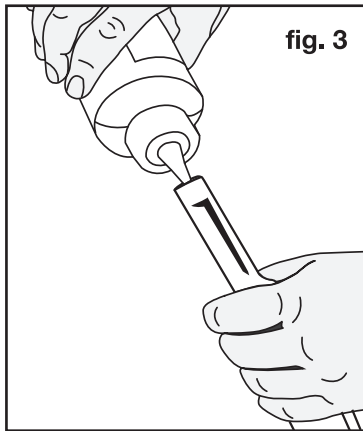
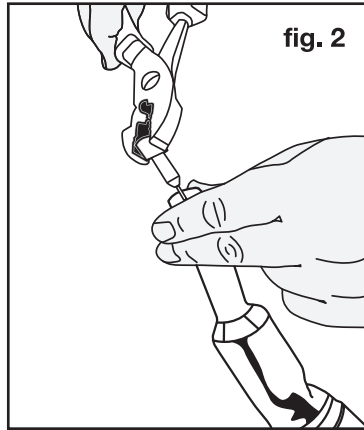
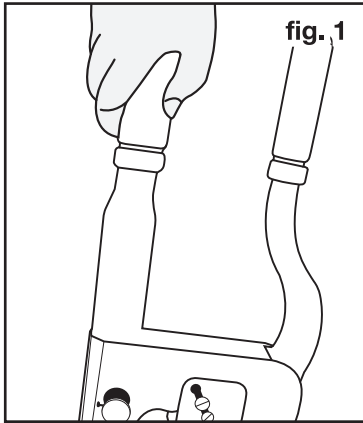

Periodically lubricate all moving parts with light weight oil as needed.
Periodically Check Cutter for blade sharpness or damage, if damage or dullness is detected do not use device and contact repair facility.

SPECIFICATIONS

Model # MP-HSP
Stock # 58946501
Length: 17.5"
Width: 10.5"

Height: 2.5"
Weight: 11 lbs.
Knock out size: 7/8" or 1 11/32"

WARRANTY

LIMITED WARRANTY

With respect to new Southwire Contractor Equipment ("SCE"; formerly known as Maxis) products, Southwire Company, LLC warrants as follows: Each SCE product will be free from defects in materials and workmanship for a period of one year from the date on which the product is delivered to the end user. This warranty does not cover normal wear and tear resulting from product use, nor does it cover damage arising out of misuse, abuse, modification, and/or improper product maintenance. This warranty also does not cover SCE products that have been modified by any party other than Southwire Company, LLC. This limited warranty is not transferrable to or enforceable by any person other than the product's original end user.

Southwire will, at its option, repair or replace defective products or defective product components, free of charge. Defective products and product components should be shipped to Southwire at the below address. Southwire will cover standard freight charges (i.e., parcel post or UPS Ground rate) incurred in connection with products that Southwire ultimately determines to be defective. Southwire will ship repaired or replacement products to the Distributor, freight prepaid. The remedy set forth in this Limited Warranty section constitutes the Distributor's and original end user's exclusive remedy for defective SCE products.

SOUTHWIRE MAKES NO WARRANTY THAT SCE PRODUCTS WILL BE MERCHANTABLE OR FIT FOR ANY PARTICULAR PURPOSE. SOUTHWIRE MAKES NO OTHER WARRANTY, EXPRESSED OR IMPLIED, OTHER THAN THE WARRANTY SPECIFICALLY SET FORTH IN THIS LIMITED WARRANTY SECTION. SOUTHWIRE WILL NOT BE LIABLE FOR ANY INCIDENTAL, CONSEQUENTIAL, INDIRECT, SPECIAL, OR PUNITIVE DAMAGES FOR ANY BREACH OF THIS LIMITED WARRANTY.

DISTRIBUTOR WARRANTY CLAIM PROCEDURE

1. All warranty claims must be pre-approved by the Southwire Contractor Equipment ("SCE"; formerly known as Maxis) Warranty Department.
2. All end user warranty claims must be handled through Distributor.
3. Warranty claims limited to replacement or repair of defective items per the Limited Warranty above. Distributor credit will not be issued.
4. Distributors must obtain a written Product Return Authorization before returning any allegedly defective product to Southwire. All returned products must be accompanied by a copy of the Product Return Authorization.
5. Products and accompanying Product Return Authorizations should be shipped to Southwire at the below address.
6. The product serial number and the original date of delivery must be set forth on the Product Return Authorization.
7. All defective components and defective products that Southwire replaces under the Limited Warranty will become Southwire's property and will be retained by Southwire.

CUSTOMER SERVICE

For all warranty, customer service, and product return authorizations and inquiries, please contact SCE at:

Southwire Tools & Equipment
840 Old Breman Road
Carrollton, GA, 30117
Phone Number: 1.855.SW.Tools